

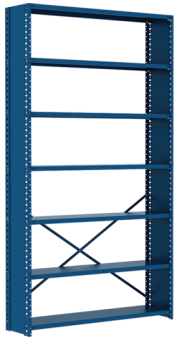

www.Borroughs.com



Effective October 1st, 2018

BOX
EDGE PLUS®

HD DRAWERS
IN SHELVING

RIVET-SPAN®
SHELVING

RECORD HOLDERS &
STORAGE

SLOTTED
ANGLE

AUTOMOTIVE
& SHOP STORAGE



ORDERING INFORMATION	3
BOX EDGE PLUS® STEEL SHELVING	
Shelving Units	4-5
Shelving Components	6-10
Shelving Specifications and Bracing	10-11
Multi-Level Shelving	12-13
HD DRAWERS IN SHELVING	
General Information	14-15
Preconfigured Units	16-19
Drawer Interior Layouts	20-26
Drawer Accessories.....	27-31
RIVET-SPAN® BOLTLESS SHELVING	
Bulk Storage Units	33
Shelf Units	34
Rivet-Span Components	35-36
Rivet-Span Specifications	37-38
RECORD HOLDERS RECORD STORAGE UNITS	
Box Edge Plus Archive & X-Ray Storage	39
Rivet Span Archive	40
SLOTTED ANGLE	
Beam/Column Sections	41
AUTOMOTIVE	
Storage	42-44
Tire Racks, Counter Units & Bulk Bins	45
Work Bench Units	46-47
Components	48-49



BORROUGHS: ORDERING INFORMATION

HOW TO ORDER

Orders may be placed by authorized Borroughs dealers.

Mail: Borroughs Corporation
Attn: Storage Products Order Entry
3002 N. Burdick Street
Kalamazoo, MI 49004-3483

Email: customerservice@borroughs.com

Storage Products: 1-800-748-0227 • Fax: 1-269-342-4161

(Orders Only) Fax: 1-800-375-1327

All orders must show quantity, catalog number, description, color and customer purchase order number. Borroughs does not assume responsibility for errors on orders not submitted in writing.

ACKNOWLEDGMENT

Borroughs will issue a written Order Acknowledgment for each order accepted. Estimated ship dates are stated on Acknowledgments. All orders are considered correct as acknowledged. **Order changes may affect estimated ship dates! Customer should review Acknowledgment promptly and notify Borroughs of any error.** Hard copy Acknowledgments will not be issued until all the engineering has been completed.

ORDER CHANGES / DELAYED SHIPMENT OR ORDER CANCELLATION BY CUSTOMER

Orders may not be cancelled or modified within 2 weeks of the estimated ship date without penalty.

Order changes, delayed shipments and cancellations by customer will generate a written acknowledgment from Borroughs. Such written acknowledgment may create a partial or full billing based upon any changes. Order Changes - Borroughs will issue a new Order Acknowledgment for each change from the original purchase order. Order Acknowledgments will include an estimated ship date. **Should the new estimated ship date cause shipment to be delayed beyond the end of a month the Customer understands and agrees that they will be billed 50% of the amount of the purchase order.** Payment terms will be the same as stated herein.

Customer Delay- **should the customer request a delay in the shipment of finished goods beyond the agreed ship date then Borroughs will be entitled to invoice the Customer the full amount of the purchase order or the unpaid portion of the purchase order.**

Customer Cancellation- **should the customer cancel an order in production the customer understands and agrees that Borroughs will bill the customer 50% of the purchase order for standard products; and 100% of the purchase order if custom products and/or paint and/or special parts or materials have been purchased by Borroughs.**

SMALL / MINIMUM ORDER POLICY

Borroughs has a \$250.00 net, plus shipping costs, minimum charge for any order processed.

SPECIAL MARKING AND PACKAGING

Custom crating, marking, palletizing or export packing is subject to special pricing; and quotations must be made in advance of order placement. Contact Borroughs' Customer Service to determine exact charges.

SHIPMENT TERMS

All orders will be shipped F.O.B. shipping point. Shipments will be "best way" with freight charged prepaid and added to invoice. Special carrier or special delivery arrangements can be accommodated. These should be requested in writing as part of the order. Special packaging costs, such as pallets, will be purchaser's responsibility.

Customer Pickup / 3rd Party / Collect Shipments – **Borroughs Shipping Department will contact the carrier that customer has chosen or our customer directly and will set up date and time for carrier to pick up order. When the date and time is scheduled, carrier has 24 hours to pick up order. Should the customer's carrier not pick up the finished products within 24 hours of the appointment, customer understands and agrees that Borroughs will then ship "best way" with freight charged prepaid and added to the invoice.**

PAYMENT TERMS

.5% - 10 days; net 30 days. (Different terms may be applied outside continental U.S.). No cash discounts on freight, taxes or services. A .5% per month finance charge will be added to all unpaid balances after 30 days.

COLOR POLICY

Product	#065 Industrial Gray	#445 White	#C386 Red	#B504 Blue	#F604 Pebble	#161 Mist Gray	#040 Black
BOX EDGE PLUS® Steel Shelving	Std.	Std.	Std.	Std.	Std.	Std.	Std.
HD Drawers	Std.	Std.	Std.	Std.	Std.	Std.	Std.
Commercial Grade Steel Shelving (RTA Clip-Type)	Std.	N/A	N/A	N/A	N/A	N/A	N/A
RIVET-SPAN®	Std.	Std.	Std.	Std.	Std.	Std.	Std.
Slotted Angle	Std.	Std.	Std.	Std.	Std.	Std.	Std.
Shop Equipment	Std.	Std.	Std.	Std.	Std.	Std.	Std.
Utility Carts (Commercial only)	Std.	N/A	N/A	N/A	N/A	N/A	N/A

NOTE: Shelf Box Partitions are #445 White.

Custom Color Upcharge: Consult Borroughs Customer Service for availability of colors other than those listed above. Custom color orders, if accepted, will be subject to manufacturing schedules and an upcharge based upon material, quantity, and color. Samples must be approved in writing before order is accepted for firm shipping date. Custom color orders are not subject to cancellation nor return and must be one order and delivery location.

DAMAGED SHIPMENTS

Responsibility - Delivery to the carrier shall constitute delivery to the customer. Borroughs' liability ends upon delivery of products to the carrier. Goods are shipped at the customer's risk. All claims for product lost or damage in transit shall be made by the customer.

Visible Damage - Should be noted on the freight bill and acknowledged by the driver's signature.

Concealed Damage - Notify the freight agent if concealed damage is found within 15 days of delivery. Request an inspection. An inspection is necessary for filing a claim.

RETURN SHIPMENTS

Return shipments may be authorized within 60 days of original shipment. You must have written authorization from Borroughs prior to any return. Authorized returns must be packaged properly using original cartons. They are to be shipped with freight prepaid by customer. All returns are subject to a 30% restocking charge for In Stock items. Custom product items, buy-out items including custom colors, may not be returned. All returns subject to any reconditioning charges determined necessary by Borroughs upon inspection of the returned goods.

PRICES

Prices in this price list supersede all previous prices and are in effect as of the date of this publication. Prices are subject to change without notice.

NOT OFFER TO SELL

Possession of this price list is not to be construed as an offer to sell the products listed. Borroughs reserves the right to discontinue any item in this list without notice. Borroughs reserves the right to change material and design specifications at any time, and without obligation to make corresponding changes in products manufactured previously.

TAXES

Any manufacturer's sales or excise tax, or any other tax or government charge now or hereafter levied upon the product, sale, use or shipment of goods shall, at the Company's options, be charged to the customer.

WARRANTY

Borroughs Corporation extends to the original purchaser from the date of purchase a **limited lifetime warranty** for Borroughs' **Automotive Workstations** and **Modular Drawer Cabinets** against manufacturing defects in material and workmanship. For all other products Borroughs extends to the original purchaser from the date of purchase a **5-year limited warranty** against manufacturing defects in material and workmanship.

If a Borroughs product fails to perform because of a manufacturing defect, Borroughs will examine it. If found defective, it will be repaired or replaced at our option.

This warranty applies only to Borroughs products acquired directly from Borroughs Corporation or from Authorized Borroughs Dealers.

This warranty does not apply to any product which has been subject to misuse, negligence, or accident; has been damaged in shipment, storage, or installation; has been misapplied or has been modified or **repaired by unauthorized persons** or been repaired with non-standard Borroughs replacement parts. This warranty specifically excludes claims for indirect, incidental, or consequential damages arising in any way from a product defect.

This warranty is exclusive, and exists in lieu of all other warranties, either expressed or implied.

This warranty gives you specific legal rights; you may also have other rights which may vary from state to state.

Contact your Borroughs Selling Dealer, to obtain warranty service. You must make a written claim. Provide a copy of your purchase record and a written description of the warranty problem with your claim.

If you are unable to contact your Dealer, contact:

Borroughs Corporation, Customer Service Manager, 3002 N. Burdick St., Kalamazoo, MI 49004-3483. Phone: 1-800-748-0227

Catalog No.	List Price	Wt.	Size (w" x d" x h")	Wt.	List Price	Catalog No.
Open Type With Plus 1 Shelf						
Starter			5 Shelves			Adder
P1-1000-3	\$213.02	71	36" x 12" x 7'3"/87"	68	\$203.50	P1-1001-3
P1-1000-4	\$248.29	84	48" x 12" x 7'3"/87"	82	\$238.78	P1-1001-4
P1-1004-3	\$249.65	88	36" x 18" x 7'3"/87"	83	\$239.78	P1-1005-3
P1-1006-3	\$289.32	102	36" x 24" x 7'3"/87"	99	\$278.95	P1-1007-3
Starter			6 Shelves			Adder
P1-1012-3	\$237.13	79	36" x 12" x 7'3"/87"	95	\$277.53	P1-1012-4
P1-1012-4	\$277.53	95	48" x 12" x 7'3"/87"	93	\$267.99	P1-1013-4
P1-1016-3	\$279.25	97	36" x 18" x 7'3"/87"	94	\$269.06	P1-1017-3
P1-1018-3	\$326.68	116	36" x 24" x 7'3"/87"	113	\$316.34	P1-1019-3
Starter			7 Shelves			Adder
P1-1024-3	\$257.84	86	36" x 12" x 7'3"/87"	84	\$248.34	P1-1025-3
P1-1024-4	\$306.72	105	48" x 12" x 7'3"/87"	103	\$297.21	P1-1025-4
P1-1028-3	\$308.86	107	36" x 18" x 7'3"/87"	105	\$298.99	P1-1029-3
P1-1030-3	\$364.02	130	36" x 24" x 7'3"/87"	127	\$353.71	P1-1031-3
Open Type						
Starter			5 Shelves			Adder
1000-3	\$228.57	71	36" x 12" x 7'3"/87"	68	\$219.05	1001-3
1000-4	\$262.04	84	48" x 12" x 7'3"/87"	82	\$252.55	1001-4
1004-3	\$269.09	88	36" x 18" x 7'3"/87"	83	\$259.23	1005-3
1004-4	\$323.71	103	48" x 18" x 7'3"/87"	101	\$313.82	1005-4
1006-3	\$309.96	102	36" x 24" x 7'3"/87"	199	\$299.66	1007-3
1006-4	\$382.39	126	48" x 24" x 7'3"/87"	123	\$372.05	1007-4
Starter			6 Shelves			Adder
1012-3	\$254.10	79	36" x 12" x 7'3"/87"	76	\$244.59	1013-3
1012-4	\$294.05	95	48" x 12" x 7'3"/87"	93	\$284.52	1013-4
1016-3	\$302.61	97	36" x 18" x 7'3"/87"	94	\$292.73	1017-3
1016-4	\$367.84	117	48" x 18" x 7'3"/87"	115	\$357.98	1017-4
1018-3	\$351.46	116	36" x 24" x 7'3"/87"	113	\$341.12	1019-3
1018-4	\$438.09	145	48" x 24" x 7'3"/87"	142	\$427.75	1019-4
Starter			7 Shelves			Adder
1024-3	\$279.64	85	36" x 12" x 7'3"/87"	84	\$270.12	1025-3
1024-4	\$326.02	105	48" x 12" x 7'3"/87"	103	\$316.48	1025-4
1028-3	\$336.11	107	36" x 18" x 7'3"/87"	105	\$326.23	1029-3
1028-4	\$412.01	131	48" x 18" x 7'3"/87"	127	\$402.14	1029-4
1030-3	\$392.94	130	36" x 24" x 7'3"/87"	127	\$382.61	1031-3
1030-4	\$493.77	163	48" x 24" x 7'3"/87"	160	\$483.47	1031-4
Starter			8 Shelves			Adder
1036-3	\$305.17	94	36" x 12" x 7'3"/87"	92	\$295.66	1037-3
1036-4	\$357.98	116	48" x 12" x 7'3"/87"	114	\$348.46	1037-4
1040-3	\$369.60	118	36" x 18" x 7'3"/87"	116	\$359.72	1041-3
1040-4	\$456.20	146	48" x 18" x 7'3"/87"	144	\$446.29	1041-4
1042-3	\$434.42	144	36" x 24" x 7'3"/87"	141	\$424.13	1043-3
1042-4	\$549.51	182	48" x 24" x 7'3"/87"	179	\$539.19	1043-4

Catalog No.	List Price	Wt.	Size (w" x d" x h")	Wt.	List Price	Catalog No.
Closed Type – Without Backs						
Starter			5 Shelves			Adder
2000-3	\$263.31	76	36" x 12" x 7'3"/87"	71	\$236.42	2001-3
2000-4	\$296.80	90	48" x 12" x 7'3"/87"	85	\$269.92	2001-4
2004-3	\$329.45	98	36" x 18" x 7'3"/87"	90	\$289.41	2005-3
2004-4	\$384.07	116	48" x 18" x 7'3"/87"	107	\$344.03	2005-4
2006-3	\$389.83	114	36" x 24" x 7'3"/87"	102	\$339.58	2007-3
2006-4	\$462.24	145	48" x 24" x 7'3"/87"	133	\$411.97	2007-4
Starter			6 Shelves			Adder
2012-3	\$288.84	84	36" x 12" x 7'3"/87"	79	\$261.95	2013-3
2012-4	\$328.77	100	48" x 12" x 7'3"/87"	95	\$301.91	2013-4
2016-3	\$362.95	109	36" x 18" x 7'3"/87"	100	\$322.91	2017-3
2016-4	\$428.20	130	48" x 18" x 7'3"/87"	121	\$388.16	2017-4
2018-3	\$431.33	120	36" x 24" x 7'3"/87"	116	\$381.06	2019-3
2018-4	\$517.96	164	48" x 24" x 7'3"/87"	141	\$467.69	2019-4
Starter			7 Shelves			Adder
2024-3	\$314.37	92	36" x 12" x 7'3"/87"	87	\$287.49	2025-3
2024-4	\$360.75	111	48" x 12" x 7'3"/87"	106	\$333.86	2025-4
2028-3	\$396.46	120	36" x 18" x 7'3"/87"	111	\$356.40	2029-3
2028-4	\$472.36	144	48" x 18" x 7'3"/87"	136	\$432.30	2029-4
2030-3	\$472.79	142	36" x 24" x 7'3"/87"	130	\$422.54	2031-3
2030-4	\$573.65	182	48" x 24" x 7'3"/87"	170	\$523.40	2031-4
Starter			8 Shelves			Adder
2036-3	\$339.88	100	36" x 12" x 7'3"/87"	95	\$313.02	2037-3
2036-4	\$392.71	121	48" x 12" x 7'3"/87"	116	\$365.83	2037-4
2040-3	\$429.94	131	36" x 18" x 7'3"/87"	122	\$389.87	2041-3
2040-4	\$516.52	159	48" x 18" x 7'3"/87"	150	\$476.45	2041-4
2042-3	\$514.29	156	36" x 24" x 7'3"/87"	144	\$464.02	2043-3
2042-4	\$629.37	201	48" x 24" x 7'3"/87"	189	\$579.12	2043-4
Closed Type – With Backs (backs painted #445 White)						
Starter			5 Shelves			Adder
3000-3	\$340.64	96	36" x 12" x 7'3"/87"	92	\$313.73	3001-3
3000-4	\$403.90	117	48" x 12" x 7'3"/87"	112	\$376.99	3001-4
3004-3	\$406.76	119	36" x 18" x 7'3"/87"	110	\$366.74	3005-3
3004-4	\$491.12	143	48" x 18" x 7'3"/87"	135	\$451.10	3005-4
3006-3	\$467.14	142	36" x 24" x 7'3"/87"	130	\$416.90	3007-3
3006-4	\$569.33	173	48" x 24" x 7'3"/87"	160	\$519.08	3007-4
Starter			6 Shelves			Adder
3012-3	\$366.17	104	36" x 12" x 7'3"/87"	99	\$339.26	3013-3
3012-4	\$435.84	128	48" x 12" x 7'3"/87"	123	\$408.96	3013-4
3016-3	\$440.28	130	36" x 18" x 7'3"/87"	121	\$400.21	3017-3
3016-4	\$535.28	158	48" x 18" x 7'3"/87"	149	\$495.24	3017-4
3018-3	\$508.64	156	36" x 24" x 7'3"/87"	144	\$458.38	3019-3
3018-4	\$625.06	191	48" x 24" x 7'3"/87"	179	\$574.75	3019-4
Starter			7 Shelves			Adder
3024-3	\$391.71	112	36" x 12" x 7'3"/87"	107	\$364.80	3025-3
3024-4	\$467.81	138	48" x 12" x 7'3"/87"	123	\$440.92	3025-4
3028-3	\$473.78	140	36" x 18" x 7'3"/87"	121	\$433.71	3029-3
3028-4	\$579.46	163	48" x 18" x 7'3"/87"	149	\$539.37	3029-4
3030-3	\$550.13	170	36" x 24" x 7'3"/87"	144	\$499.88	3031-3
3030-4	\$680.75	210	48" x 24" x 7'3"/87"	179	\$630.48	3031-4
Starter			8 Shelves			Adder
3036-3	\$417.24	120	36" x 12" x 7'3"/87"	115	\$390.34	3037-3
3036-4	\$499.76	149	48" x 12" x 7'3"/87"	144	\$472.91	3037-4
3040-3	\$507.28	151	36" x 18" x 7'3"/87"	142	\$467.19	3041-3
3040-4	\$623.61	186	48" x 18" x 7'3"/87"	177	\$583.55	3041-4
3042-3	\$591.61	184	36" x 24" x 7'3"/87"	172	\$541.37	3043-3
3042-4	\$736.42	228	48" x 24" x 7'3"/87"	216	\$686.19	3043-4

Catalog No.	List Price	Wt.	Size (w" x d" x h")	Wt.	List Price	Catalog No.
Bin Type (backs painted #445 White)						
Starter						Adder
4012	\$468.23	119	36" x 12" x 7'3"/87"	114	\$442.93	4013
4016	\$548.46	152	36" x 18" x 7'3"/87"	143	\$508.40	4017
4018	\$647.59	186	36" x 24" x 7'3"/87"	174	\$597.33	4019
Starter						Adder
4036	\$628.57	142	36" x 12" x 7'3"/87"	138	\$604.23	4037
4040	\$648.52	185	36" x 18" x 7'3"/87"	176	\$608.44	4041
4042	\$776.02	228	36" x 24" x 7'3"/87"	216	\$725.78	4043
Starter						Adder
4048	\$721.75	157	36" x 12" x 7'3"/87"	152	\$696.46	4049
4052	\$761.90	206	36" x 18" x 7'3"/87"	197	\$712.88	4053
4054	\$914.29	257	36" x 24" x 7'3"/87"	244	\$851.20	4055
Starter						Adder
4112	\$561.68	142	36" x 12" x 7'3"/87"	137	\$534.78	4113
4116	\$663.71	174	36" x 18" x 7'3"/87"	166	\$623.67	4117
4118	\$762.82	208	36" x 24" x 7'3"/87"	196	\$712.58	4119
Starter						Adder
4124	\$617.14	152	36" x 12" x 7'3"/87"	147	\$591.12	4125
4128	\$687.14	188	36" x 18" x 7'3"/87"	179	\$647.10	4129
4130	\$797.32	227	36" x 24" x 7'3"/87"	214	\$747.08	4131
Starter						Adder
4148	\$811.43	178	36" x 12" x 7'3"/87"	173	\$783.50	4149
4152	\$834.29	228	36" x 18" x 7'3"/87"	219	\$799.96	4153
4154	\$1,000.73	278	36" x 24" x 7'3"/87"	266	\$950.48	4155
Starter						Adder
4172	\$990.48	202	36" x 12" x 7'3"/87"	197	\$961.56	4173
4176	\$1,049.52	262	36" x 18" x 7'3"/87"	253	\$1,014.32	4177
4178	\$1,259.20	322	36" x 24" x 7'3"/87"	309	\$1,208.91	4179
Starter						Adder
4184	\$1,485.71	252	36" x 12" x 7'3"/87"	247	\$1,457.14	4185
4188	\$1,603.81	348	36" x 18" x 7'3"/87"	340	\$1,561.90	4189
4190	\$1,942.86	432	36" x 24" x 7'3"/87"	419	\$1,891.70	4191
Starter						Adder
4206	\$1,878.10	263	36" x 12" x 7'3"/87"	259	\$1,872.80	4207
4208	\$2,057.14	345	36" x 18" x 7'3"/87"	336	\$2,015.35	4209
4210	\$2,266.67	445	36" x 24" x 7'3"/87"	433	\$2,243.66	4211
Starter						Adder
4212	\$3,238.10	365	36" x 12" x 7'3"/87"	360	\$3,178.67	4213
4214	\$3,561.90	481	36" x 18" x 7'3"/87"	472	\$3,523.81	4215
4216	\$3,847.62	590	36" x 24" x 7'3"/87"	577	\$3,804.15	4217
Cabinet Type (backs painted #445 White)						
Starter						Adder
5012	\$845.71	162	36" x 12" x 7'3"/87"	157	\$816.30	5013
5016	\$895.24	187	36" x 18" x 7'3"/87"	179	\$940.95	5017
5018	\$990.48	214	36" x 24" x 7'3"/87"	201	\$933.33	5019
Starter						Adder
5112	\$1,100.42	169	36" x 12" x 7'3"/87"	164	\$1,075.12	5113
5116	\$1,150.29	194	36" x 18" x 7'3"/87"	183	\$1,110.23	5117
5118	\$1,245.71	221	36" x 24" x 7'3"/87"	208	\$1,190.06	5119

Catalog No.	List Price	Wt.	Size (w" x d" x h")	Wt.	List Price	Catalog No.
7630	\$494.27	127	42" x 30" x 40"	120	\$461.10	7631
Open Vertical Storage						
Starter						Adder
8006	\$381.04	89	36" x 12" x 7'3"/87"	87	\$371.50	8007
8008	\$421.49	99	36" x 18" x 7'3"/87"	97	\$415.58	8009
8010	\$456.23	112	36" x 24" x 7'3"/87"	109	\$445.91	8011
Starter						Adder
8200	\$338.28	102	36" x 36" x 7'3"/87"	100	\$436.84	8201
Closed Vertical Storage (backs painted #445 White)						
Starter						Adder
8100	\$471.50	116	36" x 12" x 7'3"/87"	111	\$446.51	8101
8102	\$538.09	141	36" x 18" x 7'3"/87"	132	\$498.00	8103
8104	\$618.56	167	36" x 24" x 7'3"/87"	155	\$568.32	8105

Catalog No.	Size	Wt. Each	Qty. Per Pack	List Price
Angle Posts				
09534-099	3'3"/39"	2.7	8	\$8.39
09534-098	4'3"/51"	3.5	8	10.85
09534-097	5'3"/63"	4.2	8	13.37
09534-096	6'3"/75"	5.2	8	15.51
09534-095	7'3"/87"	5.9	8	17.60
09534-094	8'3"/99"	3.3	8	19.91
09534-093	9'3"/111"	7.5	8	25.71
09534-092	10'3"/123"	8.3	8	26.42
09534-091	11'3"/135"	9.8	8	29.79
09534-090	12'3"/147"	10.7	8	33.01
09534-089	13'3"/159"	11.6	8	35.70
09534-088	14'3"/171"	12.2	8	38.14
09534-087	15'3"/183"	13.4	8	40.84
09534-086	16'3"/195"	14.5	8	45.32
09534-085	14'6"/174"	12.4	8	39.93
Beaded Posts				
14933-000	75"	10.3	4	\$30.98
14933-001	87"	11.9	4	35.08
14933-015	96"	13.4	4	39.77
14933-002	99"	13.5	4	39.77
14933-003	111"	15.2	4	50.51
14933-004	123"	16.8	4	52.76
14933-008	147"	21.4	4	66.03
14933-009	171"	24.4	4	76.26
14933-010	195"	28.9	4	86.86
Beaded Post Closed Sides (height x depth)				
14938-000	6'3" x 12"	21.6	4	\$78.39
14938-006	7'3" x 12"	25	4	91.41
14938-012	9'3" x 12"	26.5	4	104.38
14938-018	11'3" x 12"	28.5	4	117.60
14938-024	10'3" x 12"	30.5	4	137.28
14938-001	6'3" x 15"	23.1	4	83.95
14938-007	7'3" x 15"	25.5	4	97.22
14938-013	8'3" x 15"	28.7	4	111.93
14938-025	12'3" x 15"	31.5	4	143.89
14938-002	6'3" x 18"	24.7	4	89.44
14938-008	7'3" x 18"	27.2	4	103.15
14938-014	8'3" x 18"	30.9	4	119.42
14938-020	9'3" x 18"	30.5	4	134.21
14938-026	10'3" x 18"	32.5	4	150.55
14938-003	7'5" x 24"	27.9	4	98.43
14938-009	8'7" x 24"	32.2	4	114.97
14938-015	9'9" x 24"	32.6	4	131.20
14938-021	9'3" x 24"	34.6	4	147.53
14938-027	10'3" x 24"	36.6	4	165.56
14938-010	7'3" x 30"	31.5	4	122.82
14938-016	8'3" x 30"	34.7	4	140.99
14938-022	9'3" x 30"	37.9	4	156.45
14938-028	10'3" x 30"	40.4	4	205.94
Post Splicers				
09545-099	Post splicer	0.8	25	\$11.12
09365-000	Splice/Bar	0.5	20	9.13
09366-000	Splice/Plate	0.3	20	9.26
14934-000	B.P. Splice Kit	0.7	40	15.95

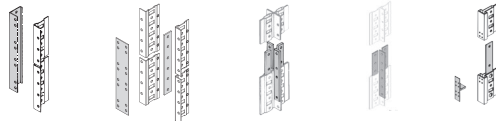

Catalog No.	Size	Wt. Each	Qty. Per Pack	List Price
Angle Post Closed Sides (height x depth)				
09608-098	3'3"/39" x 12"	7.7	4	\$34.40
09608-091	4'3"/51" x 12"	10.2	4	\$44.61
09608-084	5'3"/63" x 12"	12.2	4	\$47.66
09608-077	6'3"/75" x 12"	14.4	4	\$53.30
09608-070	7'3"/87" x 12"	16.7	4	\$59.12
09608-063	8'3"/99" x 12"	18.2	4	\$68.46
09608-056	9'3"/111" x 12"	20.9	2	\$102.78
09608-049	10'3"/123" x 12"	22.7	2	\$108.53
09608-027	16'3"/195" x 12"	42.5	2	\$168.69
09608-097	3'3"/39" x 15"	8.6	4	\$37.22
09608-076	6'3"/75" x 15"	16	4	\$57.75
09608-069	7'3"/87" x 15"	18.6	4	\$68.50
09608-062	8'3"/99" x 15"	19.7	4	\$75.24
09608-055	9'3"/111" x 15"	22.5	2	\$112.23
09608-048	10'3"/123" x 15"	25.3	2	\$120.91
09608-096	3'3"/39" x 18"	9.5	4	\$40.38
09608-089	4'3"/51" x 18"	12.4	4	\$55.09
09608-082	5'3"/63" x 18"	15.1	4	\$56.23
09608-075	6'3"/75" x 18"	17.5	4	\$63.16
09608-068	7'3"/87" x 18"	20.6	4	\$71.35
09608-061	8'3"/99" x 18"	23.1	4	\$83.24
09608-054	9'3"/111" x 18"	29.4	2	\$120.46
09608-047	10'3"/123" x 18"	33.9	2	\$133.90
09608-043	11'3"/135" x 18"	36.1	2	\$145.33
09608-041	12'3"/147" x 18"	39	2	\$150.93
09608-039	13'3"/159" x 18"	41.9	2	\$158.02
09608-037	14'3"/171" x 18"	45.3	2	\$169.56
09608-035	15'3"/183" x 18"	48.3	2	\$176.91
09608-025	16'3"/195" x 18"	50.6	2	\$197.71
09608-095	3'3"/39" x 24"	10.9	4	\$45.26
09608-088	4'3"/51" x 24"	14.4	4	\$57.52
09608-081	5'3"/63" x 24"	17.6	4	\$70.10
09608-074	6'3"/75" x 24"	20.8	4	\$78.25
09608-067	7'3"/87" x 24"	24.2	4	\$85.07
09608-060	8'3"/99" x 24"	29	2	\$101.83
09608-053	9'3"/111" x 24"	32.3	2	\$133.33
09608-046	10'3"/123" x 24"	36.3	2	\$154.97
09608-042	11'3"/135" x 24"	40	2	\$164.11
09608-040	12'3"/147" x 24"	42.8	2	\$166.74
09608-038	13'3"/159" x 24"	46	2	\$178.29
09608-036	14'3"/171" x 24"	49.8	2	\$192.50
09608-034	15'3"/183" x 24"	53	2	\$206.17
09608-024	16'3"/195" x 24"	56.1	2	\$223.43
09608-094	3'3"/39" x 30"	12.4	2	\$65.30
09608-087	4'3"/51" x 30"	15.2	2	\$72.65
09608-066	7'3"/87" x 30"	27.9	2	\$104.57
09608-059	8'3"/99" x 30"	31.1	2	\$119.81
09608-045	10'3"/123" x 30"	38.9	2	\$204.88
09608-072	6'3"/75" x 36"	27.3	2	\$125.98
09608-065	7'3"/87" x 36"	31.6	2	\$121.79
09608-058	8'3"/99" x 36"	36.1	2	\$140.72
09608-044	10'3"/123" x 36"	44.4	2	\$220.88
09608-022	16'3"/195" x 36"	74.7	2	\$259.92
Foot Plates**				
14952-000	Footplate Kit	0.4	80	\$4.17
14953-000	Footplate Kit Back-to-Back	0.5	59	\$5.10
Shim Plates**				
14951-000	Shim plate	0.1		\$2.75
14949-000	Shim plate Back-To-Back	0.2		\$2.90
Post Accessories**				
05114-828	Post Foot Plate	0.1	25	\$3.28
08702-829	Post Foot Angle	0.2	25	\$7.16
04636-000	Post Shim Plate	0.03	500	\$1.10

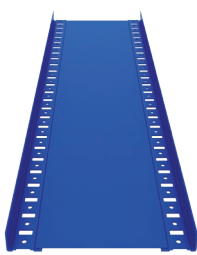

**Available in #330 Aluminum only.

Catalog No.	Size	Wt. Each	Qty. Per Pack	List Price
-------------	------	----------	---------------	------------

Shelving Backs (weight x height)

09551-099	24" x 7'3"/87"	15.1	5	\$63.18
09547-097	36" x 3'3"/39"	9.9	5	\$55.14
09548-097	36" x 4'3"/51"	13.1	5	\$61.89
09549-097	36" x 5'3"/63"	16.2	5	\$70.18
09550-097	36" x 6'3"/75"	19.3	5	\$78.07
09551-097	36" x 7'3"/87"	22.5	5	\$86.11
14867-097	36" x 8'3"/99"	25.7	5	\$107.71
09547-096	42" x 3'3"/39"	11.4	5	\$64.68
09548-096	42" x 4'3"/51"	15.2	5	\$73.71
09549-096	42" x 5'3"/63"	18.8	5	\$82.00
09550-096	42" x 6'3"/75"	22.4	5	\$94.25
09551-096	42" x 7'3"/87"	26.2	5	\$101.14
14867-096	42" x 8'3"/99"	29.9	5	\$124.64
09547-095	48" x 3'3"/39"	13	5	\$69.14
09548-095	48" x 4'3"/51"	17.2	5	\$79.50
09549-095	48" x 5'3"/63"	21.4	5	\$90.46
09550-095	48" x 6'3"/75"	25.6	5	\$102.32
09551-095	48" x 7'3"/87"	29.8	5	\$118.43
14867-095	48" x 8'3"/99"	34	5	\$137.50

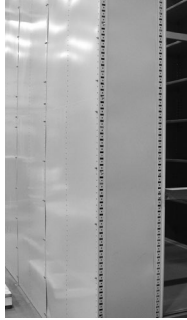

Cross Braces (price per pair)

13826-000	Back Brace 24"	2	12	\$10.51
13828-000	Back Brace 36"	2.4	12	\$11.57
05017-815	Back Brace 42"	2.6	12	\$12.08
05165-815	Back Brace 48"	2.8	12	\$12.88
05019-815	Side Brace 12"	1.4	12	\$9.54
05583-815	Side Brace 15"	1.6	12	\$9.64
05020-815	Side Brace 18"	1.8	12	\$9.91
13829-000	Side Brace 24"	2	12	\$10.34
13830-000	Side Brace 30"	2.2	12	\$10.93
10445-000	Side Brace 32"	2.2	12	\$11.21
13831-000	Side Brace 36"	2.4	12	\$11.46

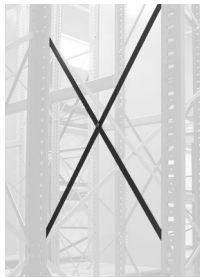

Face Braces (price per pair)

10462-000	Angle Post	1.4	20	\$17.52
10463-000	Beaded Post	1.6	20	\$22.93

Perforated Back Panels

14899-001-XXX	36" w x 51" h	31.07		\$170.17
14899-002-XXX	36" w x 39" h	23.69		\$129.54
14899-003-XXX	48" w x 51" h	41.63		\$200.61
14899-004-XXX	48" w x 39" h	31.75		\$175.68







Catalog No.	Size	Wt. Each	Qty. Per Pack	List Price
-------------	------	----------	---------------	------------

Box Edge Plus® Shelves

Plus 0 (24 ga.) (width x depth) wt. ea. pack/pallet				
10448-001	36" x 12"	4.25	10/200	\$20.02
10448-002	36" x 18"	6.8	10/120	\$26.11
10448-003	36" x 24"	7	10/80	\$32.78
10448-004	48" x 12"	5.58	10/180	\$23.84
10448-005	48" x 18"	9.1	6/90	\$34.22
10448-006	48" x 24"	9.2	6/60	\$43.18
Plus 1 (22 ga.) (width x depth) wt. ea. pack/pallet				
10437-000	24" x 12"	4.3	10/360	\$37.83
10437-001	36" x 12"	6.2	10/200	\$22.44
10437-003	48" x 12"	8.3	10/180	\$29.22
10446-001	36" x 15"	7.3	10/120	\$28.67
10439-000	24" x 18"	5.6	10/240	\$42.93
10439-001	36" x 18"	8.2	10/120	\$29.61
10439-002	42" x 18"	9.4	10/180	\$34.78
10439-003	48" x 18"	11	6/90	\$39.93
10441-000	24" x 24"	7	10/120	\$45.79
10441-001	36" x 24"	10.2	10/80	\$37.37
10441-003	48" x 24"	13.7	6/60	\$50.11
Plus 2 (20 ga.) (width x depth) wt. ea. pack/pallet				
10428-001	36" x 12"	7.4	10/120	\$25.53
10428-002	42" x 12"	8.6	10/180	\$29.19
10428-003	48" x 12"	9.7	10/180	\$32.01
10429-001	36" x 15"	8.6	10/120	\$32.56
10429-002	42" x 15"	10	10/120	\$34.62
10429-003	48" x 15"	11.3	6/120	\$37.86
10430-001	36" x 18"	9.7	10/120	\$33.52
10430-002	42" x 18"	11.4	10/120	\$40.25
10430-003	48" x 18"	12.9	6/120	\$44.18
10432-001	36" x 24"	12.2	10/120	\$41.50
10432-002	42" x 24"	14.2	6/60	\$48.03
10432-003	48" x 24"	16.1	6/60	\$55.74
10434-001	36" x 30"	14.6	6/60	\$51.41
10434-002	42" x 30"	16.9	6/60	\$58.85
10434-003	48" x 30"	19.2	6/60	\$66.92
10435-002	42" x 32"	17	6/60	\$63.54
10436-001	36" x 36"	17	6/60	\$62.79
10436-002	42" x 36"	19.7	6/60	\$68.83
10436-003	48" x 36"	22.4	6/60	\$77.77
Plus 3 (18 ga.) (width x depth) wt. ea. pack/pallet				
10419-001	36" x 12"	9.9	10/120	\$32.90
10419-002	42" x 12"	11.5	10/180	\$38.53
10419-003	48" x 12"	13	10/180	\$42.05
10420-001	36" x 15"	11.5	10/120	\$40.08
10420-002	42" x 15"	13.3	10/120	\$43.98
10420-003	48" x 15"	15.1	6/120	\$48.07
10421-001	36" x 18"	13.1	10/120	\$41.02
10421-002	42" x 18"	15.2	10/120	\$48.41
10421-003	48" x 18"	17.3	6/120	\$54.55
10423-001	36" x 24"	16.3	10/120	\$49.28
10423-002	42" x 24"	18.9	6/60	\$57.66
10423-003	48" x 24"	21.5	6/60	\$66.06
10425-001	36" x 30"	19.6	6/60	\$59.53
10425-002	42" x 30"	22.6	6/60	\$69.05
10425-003	48" x 30"	25.7	6/60	\$77.84
10426-002	42" x 32"	23.9	6/60	\$73.92
10427-001	36" x 36"	22.8	6/60	\$69.53
10427-002	42" x 36"	26.3	6/60	\$79.51
10427-003	48" x 36"	30	6/60	\$89.05
Extra Brackets				
09531-099	500 pack	0.07	500	\$0.89

PLEASE NOTE:
All shelves punched on 1" centers for shelf dividers, except for 42" x 30" and 42" x 32" which have no divider holes.

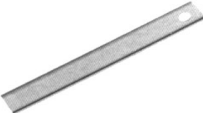
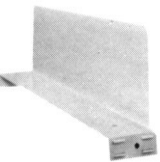
PLEASE NOTE:
To order palletized quantity, add a "P" to the part number after the color number.
EXAMPLE:
10437-001-065 changes to 10437-001-065P

	Catalog No.	Size	Wt. Each	Qty. Per Pack	List Price
	Shelf Saddles				
	09610-095	48" w	3.6	12	\$18.10
	09610-096	42" w	3.1	12	\$16.19
	09610-097	36" w	2.7	12	\$15.28
	Shelf Side Supports <small>(price per pair)</small>				
	09555-098	12" d	1.2	12	\$19.24
	09555-096	18" d	1.9	12	\$21.64
	09555-095	24" d	2.6	12	\$22.29
	09555-094	30" d	3.3	12	\$23.43
	09555-093	36" d	3.9	12	\$26.48
	Base Strips – Angle Posts				
	09554-099	24" w	0.6	24	\$7.05
	09554-097	36" w	0.9	24	\$7.05
	09554-096	42" w	1	24	\$7.41
	09554-095	48" w	1.2	24	\$7.94
	Base Strips – Beaded Posts				
	09614-097	36" w	1	24	\$10.11
	09614-096	42" w	1.2	24	\$10.70
	09614-095	48" w	1.3	24	\$11.06
	Label Holders				
	09656-099	24" w	0.1	100	\$4.52
	09656-097	36" w	0.2	100	\$5.28
	09656-096	42" w	0.2	100	\$5.80
	09656-095	48" w	0.3	100	\$6.20
10460-000-00	Label holder Magnetic	0.8	100	\$13.20	
	Sliding Shelf Dividers <small>(height x depth)</small>				
	14745-000	4-1/2" x 12"	0.8	36	\$12.00
	14745-001	4-1/2" x 15"	1	36	\$15.81
	14745-002	4-1/2" x 18"	1.2	36	\$16.95
	14745-003	4-1/2" x 24"	1.6	36	\$18.10
	14745-004	6" x 12"	0.8	36	\$19.09
	14745-005	6" x 15"	1.1	36	\$15.44
	14745-006	6" x 18"	1.3	36	\$20.38
14745-007	6" x 24"	1.7	36	\$21.52	
	Boltless Hang Bars <small>(width x depth)</small>				
	10140-000	24" x 18"	2.3	6	\$72.61
	10140-004	24" x 24"	3	6	\$71.24
	10140-001	36" x 18"	2.9	6	\$81.52
	10140-005	36" x 24"	3.6	6	\$83.96
	10140-002	48" x 18"	3.3	6	\$82.48

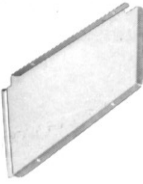
	Catalog No.	Size	Wt. Each	Qty. Per Pack	List Price
	Shelf Dividers Fixed <small>(height x depth)</small>				
	05599-807	6" x 12"	0.7	60	\$11.43
	05606-807	9" x 12"	1	40	\$13.45
	05613-807	12" x 12"	1.4	32	\$18.97
	05620-807	15" x 12"	1.7	20	\$19.92
	05627-807	18" x 12"	2	20	\$20.69
	05600-807	6" x 15"	0.8	60	\$16.50
	05607-807	9" x 15"	1.5	40	\$14.29
	05614-807	12" x 15"	1.8	32	\$19.92
	05621-807	15" x 15"	2	20	\$20.69
	05628-807	18" x 15"	2.7	20	\$22.21
	05601-807	6" x 18"	1.1	48	\$11.81
	05608-807	9" x 18"	1.6	32	\$14.48
	05615-807	12" x 18"	2.1	20	\$20.69
	05622-807	15" x 18"	2.6	16	\$21.83
	14374-807	16 1/2" x 18"	2.8	16	\$22.01
	05629-807	18" x 18"	3	16	\$22.86
	05643-807	24" x 18"	4.3	10	\$27.62
	05602-807	6" x 24"	1.4	48	\$14.17
	05609-807	9" x 24"	2.1	32	\$21.74
	05616-807	12" x 24"	2.7	20	\$14.76
	05623-807	15" x 24"	3.4	16	\$18.62
05630-807	18" x 24"	4	16	\$21.53	
05637-807	21" x 24"	4.5	10	\$26.08	
05644-807	24" x 24"	5.2	10	\$36.19	
05604-807	6" x 36"	2.2	30	\$18.30	
05611-807	9" x 36"	3.5	20	\$22.86	
05618-807	12" x 36"	4.3	20	\$25.52	
Divider and Label Holder Fastner					
	47955-000	Push-in Rivet			\$0.21
Long Parts Frame					
	09576-099	36" x 12"	5	10	\$44.41
	06238-860	Rod - 12"	0.3	50	\$0.99
	09576-098	36" x 18"	5.6	10	\$47.16
	06239-860	Rod - 18"	0.4	50	\$5.14
	09576-097	36" x 24"	6.1	10	\$50.36
	06240-860	Rod - 24"	0.3	50	NA
Shelf Lock					
	08703-823				\$3.85

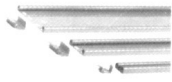

Note
Clips provided for 1-1/2" angle post bin front. Bolts are provided for all other sizes.

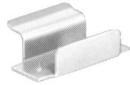

Catalog No.	Size	Wt. Each	Qty. Per Pack	List Price
Bin Fronts – Angle Posts				
05698-819	36" x 1-1/2"	2.2	25	\$11.65
05701-819	42" x 1-1/2"	2.6	25	\$18.30
05704-819	48" x 1-1/2"	2.7	25	\$18.62
09557-099	24" x 3"	2	25	\$21.20
09557-097	36" x 3"	3.2	25	\$13.18
09557-096	42" x 3"	3.8	25	\$18.17
09557-095	48" x 3"	4.1	25	\$18.60
09558-097	36" x 6"	4.5	12	\$23.07
09558-096	42" x 6"	5.3	12	\$31.42
09558-095	48" x 6"	6	12	\$37.11
Bin Front Clips – Angle Posts <small>(available in #330 Aluminum only)</small>				
05707-835	1-1/2"	0.1	100	\$4.23
05708-836	3" and 6"	0.1	50	\$3.24
Bin Fronts – Beaded Posts				
09615-097	36" x 1-1/2"	2.5	24	\$22.04
09616-097	36" x 3"	3.2	12	\$27.13
Spray Paint				
14219-000	12oz can		12	\$37.53

Specify any standard color

Swing-type doors for angle post shelving are made of 20 gauge cold-rolled steel with a 3-point locking door handle. Doors consist of fully contained welded steel frame, which bolts to the face of the unit simply and easily. Framed doors are available to fit shelving up to 7'3" tall. Two or more standard-sized doors are used for heights of 7'3". A special 4'0" high door is made for use above ledges. Doors will fit high density drawer units. Doors are not compatible with Beaded Post or Beaded Closed Sides. Adds 2-1/16" to depth of unit.



Framed Swing Doors – Angle Post
(width x height) – price per pair

13402-001	36" x 39"	29.6	1pr	\$377.52
13404-001	36" x 48"	36.3	1pr	\$404.38
13402-005	36" x 51"	37	1pr	\$390.59
13402-013	36" x 75"	54.4	1pr	\$466.48
13402-017	36" x 87"	61	1pr	\$504.30
13402-002	42" x 39"	40.3	1pr	\$400.59
13402-014	42" x 75"	56	1pr	\$536.49
13402-018	42" x 87"	68.5	1pr	\$535.81
13402-003	48" x 39"	35.7	1pr	\$562.76
13402-015	48" x 75"	74.4	1pr	\$500.27
13402-019	48" x 87"	87.5	1pr	\$572.80

Please Note
Doors Only.
Units must be ordered separately.

Catalog No.	Size	Wt. Each	List Price
High-Rise Posts			
14917-000	87"	14.2	\$44.41
14917-001	99"	16.2	\$48.69
14917-002	111"	18.2	\$58.10
14917-003	123"	20.1	\$62.29
14917-004	147"	24.1	\$72.42
14917-008	159"	29.6	\$78.74
14917-005	183"	29.9	\$115.66
14917-006	195"	31.9	\$120.38
Side Panels – High-Rise Posts (height" x depth")			
14918-000	51" x 12"	5.1	\$25.45
14918-001	51" x 15"	6.4	33.90
14918-002	51" x 18"	8	33.90
14918-003	51" x 24"	10.2	43.96
14918-004	51" x 30"	12.8	61.14
14918-005	51" x 32"	14	61.90
14919-000	63" x 12"	5.8	25.90
14919-001	63" x 15"	7.3	38.40
14919-002	63" x 18"	9.1	39.05
14919-003	63" x 24"	11.6	50.21
14919-004	63" x 30"	14.5	62.21
14919-005	63" x 32"	15.4	69.45
14920-000	12" x 87"	7.8	34.70
14920-001	15" x 87"	9.8	38.13
14920-002	18" x 87"	11.8	46.86
14920-003	24" x 87"	15.1	59.05
14920-004	30" x 87"	17.1	72.99
14920-005	32" x 87"	18.8	94.29
14920-006	36" x 87"		97.37
14921-000	99" x 12"	8.8	37.26
14921-001	15" x 99"	11	44.76
14921-002	99" x 18"	13.1	51.73
14921-003	99" x 24"	17.6	67.77
14921-004	30" x 99"	19.6	82.93
14921-005	99" x 32"	21.4	104.38
14921-006	99" x 36"		108.19
Splicer Kit – High-Rise Post			
14928-000		1.3	\$22.74
Back Braces – High-Rise Post (price per pair)			
14926-000	24"	2	\$11.44
14926-001	36"	2.4	\$12.56
14926-002	42"	2.6	\$13.16
14926-003	48"	2.8	\$14.05
Back Attachment Kit – High-Rise*			
*4 brackets per kit - one kit needed per pair of braces. Locate brackets on 30" centers for backs.			
14927-001		1	\$8.25
Mezzanine Bracket – High-Rise Post			
14941-000	Kit Mezzanine Support Bracket	0.8	\$13.33
Catwalk Beams – High-Rise Post			
10134-000	30" x 2-3/4" h	5.1	\$29.95
10134-001	36" x 2-3/4" h	5.8	\$32.44
10134-002	42" x 2-3/4" h	6.5	\$34.19
10134-003	48" x 2-3/4" h	7.3	\$42.22

Basic Data

Widths

Nominal unit width: 24", 36", 42" or 48"
Actual beaded post unit width is the nominal width plus 1"
Actual angle post unit width is the nominal width

Depths

Nominal depth: 12", 15", 18", 24", 30", 32" or 36"
Actual beaded post unit depth is the nominal depth plus 15/32"
with beaded post in front and angle post in back
Actual angle post unit depth is the nominal depth

Heights

Nominal height: One foot increments from 3'3"/39" to 16'3"/195"
Actual height is the nominal height minus 1/4" ±1/16"
NOTE: Unit anchoring is recommended when the height to depth ratio exceeds 4.
EXAMPLE: 7'3"/87" high x 18" deep unit has a height to depth ratio of 4.873 and should be anchored to a firm restraint such as a floor or wall

Length of Run

Actual length of beaded post shelving run in nominal unit width per unit plus 1/2" for each row end.
Actual length of angle post shelving run in nominal unit width per unit

Clear Shelf Opening

Actual clear opening between beaded posts is the nominal width minus 1"
Actual clear opening between angle posts is the nominal width minus 2"
Vertical clearance between shelves is equal to center-to-center shelf spacing minus 1-7/32"

Vertical Adjustment

All shelves are adjustable on 1-1/2" centers

Box Edge Plus® Shelf Capacities

	Box Edge Plus 0 (24 g.)	Box Edge Plus 1 (22 g.)	Box Edge Plus 2 (20 g.)	Box Edge Plus 3 (18 g.)
Size	Capacity			
24" x 12"	-	600 lbs.	-	-
36" x 12"	420 lbs.	600 lbs.	800 lbs.	1100 lbs.
42" x 12"	-	-	600 lbs.	1000 lbs.
48" x 12"	220 lbs.	400 lbs.	500 lbs.	800 lbs.
36" x 15"	-	600 lbs.	800 lbs.	1100 lbs.
42" x 15"	-	-	600 lbs.	1000 lbs.
48" x 15"	-	-	500 lbs.	800 lbs.
24" x 18"	-	600 lbs.	-	-
36" x 18"	400 lbs.	600 lbs.	800 lbs.	1200 lbs.
42" x 18"	-	-	600 lbs.	1000 lbs.
48" x 18"	210 lbs.	400 lbs.	500 lbs.	800 lbs.
24" x 24"	-	600 lbs.	-	-
36" x 24"	460 lbs.	600 lbs.	800 lbs.	1200 lbs.
42" x 24"	-	-	600 lbs.	1000 lbs.
48" x 24"	200 lbs.	400 lbs.	500 lbs.	800 lbs.
36" x 30"	-	-	600 lbs.	900 lbs.
42" x 30"	-	-	600 lbs.	1000 lbs.
48" x 30"	-	-	500 lbs.	750 lbs.
42" x 32"	-	-	650 lbs.	1000 lbs.
36" x 36"	-	-	400 lbs.	600 lbs.
42" x 36"	-	-	450 lbs.	600 lbs.
48" x 36"	-	-	450 lbs.	700 lbs.

*Contact factory for price and availability

For Units 99" and Less in Height

		Single Row							
No. Units:	8	7	6	5	4	3	2	1	
No. Braces:	10	9	8	7	6	5	4	3	

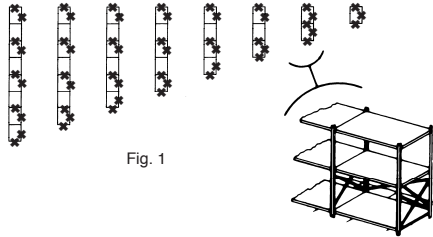

Fig. 1

		Double Row							
No. Units:	16	14	12	10	8	6	4	2	
No. Braces:	16	14	13	11	10	8	6	3	

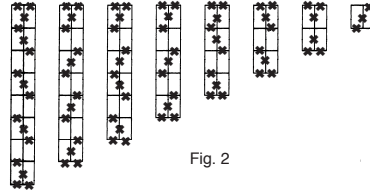

Fig. 2

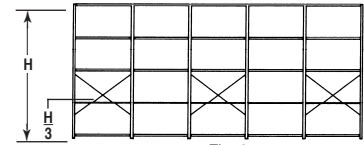

Fig. 3
Side Brace

Light Loading

Both single and double rows may use sway braces as in Figures 1 and 2. The end and back of the first and last section of each row always contains a sway brace. Every other intermediate and every other back should contain a sway brace. The height location of the sway brace is determined as in Figure 3, where the center line of the cross is "height divided by 3" up from the bottom.

NOTE: FOR CRITICAL SHELF LOCATIONS, MINOR CHANGES TO THESE RECOMMENDATIONS ARE ACCEPTABLE.

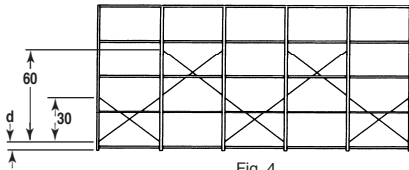

Fig. 4
Back Brace

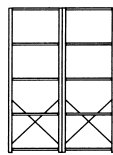

Fig. 4A
Side Brace

Standard Loading

For rigidity in standard duty applications, a pair of sway braces should be put in every opening at the heights illustrated in Figure 4. Each open end should be braced as illustrated in Figure 4A.

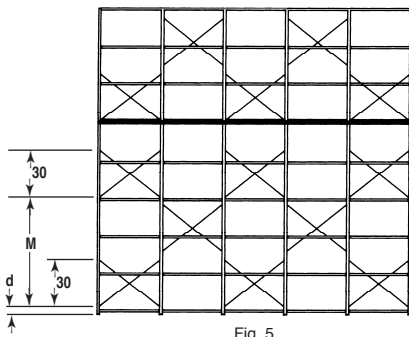

Fig. 5
Back Brace

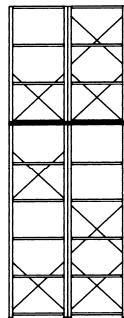

Fig. 5A
Side Brace

Connection point as close as possible to mezzanine level- may be either above or below level.

M = maximum distance possible - up to and including 30"

d = minimum reasonable distance (e.g. 4.5" - 6.0")

Multi-Level Application

For rigidity in mezzanine applications, two sway braces should be put in every other opening at the heights illustrated in Figure 5. The intervening openings should be braced with one pair of sway braces as shown. The term "d" equals the distance for mounting the sway braces to the post from the floor. Bolt the front of the center shelf and the front of the top shelf and the base strip in place. The open ends should be braced as illustrated in Figure 5A.

For Units Over 99" High

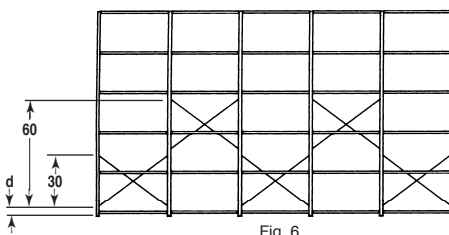

Fig. 6
Back Brace

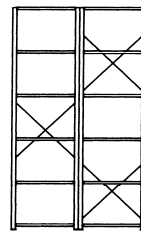

Fig. 6A
Side Brace

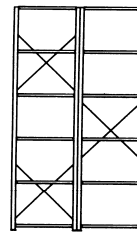

Fig. 6B
Side Brace

Light Loading

For rigidity, Borroughs recommends that one pair of sway braces be installed in each open end and open back. Sway brace height is as shown in Figure 6. Figure 6A and 6B are an end and an intermediate, respectively. The bracing patterns are opposite each other and should alternate from one end of a row down to the other end. Pre-assembly of the two uprights is identical.

NOTE: FOR CRITICAL SHELF LOCATIONS, MINOR CHANGES TO THESE RECOMMENDATIONS ARE ACCEPTABLE.

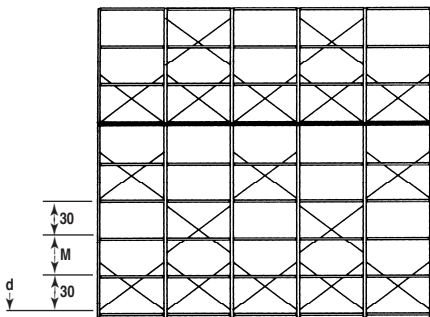

Fig. 7
Back Brace

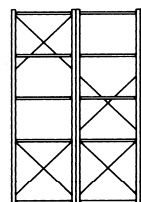

Fig. 7A
Side Brace

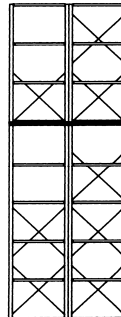

Fig. 7B
Side Brace

Connection point as close as possible to mezzanine level - may be either above or below level.

M = maximum distance possible - up to and including 30"

d = minimum reasonable distance (e.g. 4.5" - 6.0")

Standard Loading and Multi-Level

For rigidity, Borroughs recommends that sway braces be used in open backs as illustrated in Figure 7. Sway brace height is as shown in Figure 7. Bolt the front of the center shelf and the front of the top shelf and the base strip in place. Sway bracing for the ends of sections should be installed as shown in Figure 7A for heavy-duty and Figure 7B for multi-level applications.

PLEASE NOTE: FAILURE TO FOLLOW THESE SWAY BRACING RECOMMENDATIONS COULD RESULT IN AN IMPROPER INSTALLATION, SHELVING COLLAPSE, PERSONAL INJURY AND/OR COMMODITY LOSS.

BOX EDGE: POSTS, SPLICERS & BEAMS

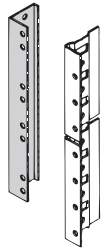

Post Splicer

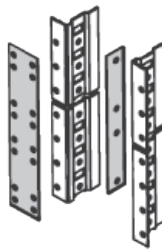

Splice Plate & Bar

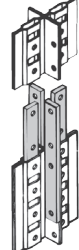

4 Splicer Bars

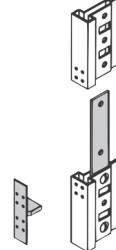

Splice Kit

Catalog No.	Size	Wt. Each	Qty. Per Pack	List Price
Post Splicers				
09545-099	Post splicer	0.8	8	\$11.12
09365-000	Splice/Bar	0.5	8	\$9.13
09366-000	Splice/Plate	0.3	8	\$9.26
14934-000	B.P Splice Kit	0.7	8	\$15.95

Mezzanine Beams

14064-000	36" x 2-1/2"	5.3	8	\$26.54
14064-001	42" x 2-3/4"	6	8	\$32.24
14064-002	48" x 2-3/4"	6.9	8	\$36.04

Mezzanine Brackets - Angle Post

14065-000	-	0.3	8	\$7.96
-----------	---	-----	---	--------

Mezzanine Bracket - Beaded Post

14941-000	-	0.8	8	\$13.33
-----------	---	-----	---	---------

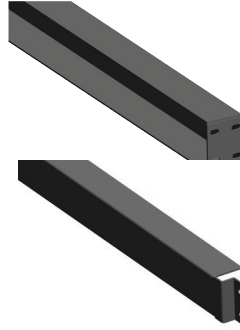

Catwalk Beams - Angle Post

10135-000	30" x 2-3/4" h	5	4	\$28.49
10135-001	36" x 2-3/4" h	5.6	4	\$30.93
10135-002	42" x 2-3/4" h	6.3	4	\$32.56
10135-003	48" x 2-3/4" h	7	4	\$40.25

Catwalk Beams - Beaded Post

10134-000	30" x 2-3/4" h	5.1	4	\$29.95
10134-001	36" x 2-3/4" h	5.8		\$32.44
10134-002	42" x 2-3/4" h	6.5		\$34.19
10134-003	48" x 2-3/4" h	7.3		\$42.22

BOX EDGE: SEISMIC RISK MAP OF THE U.S.

All areas of the United States have been zoned seismically. Each zone indicates the anticipated intensity or severity of a seismic occurrence within that region. Zones range from 0 (least likely) to 4 (most likely) to experience damage.

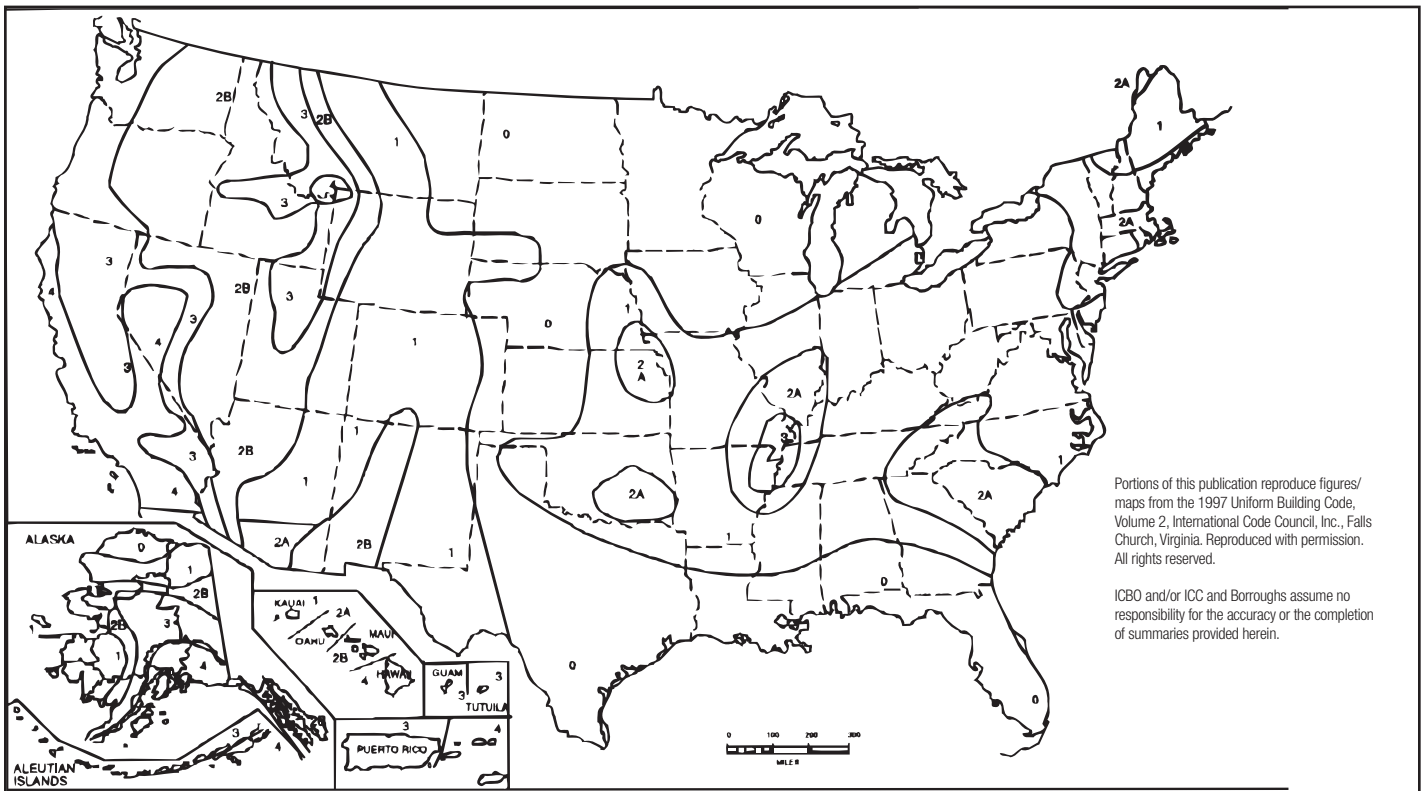

NOTE: Special care should be taken when specifying any system in a highly seismic area.



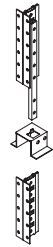
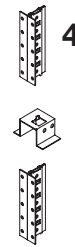
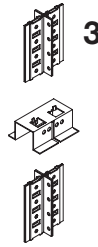
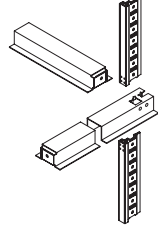
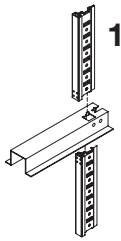
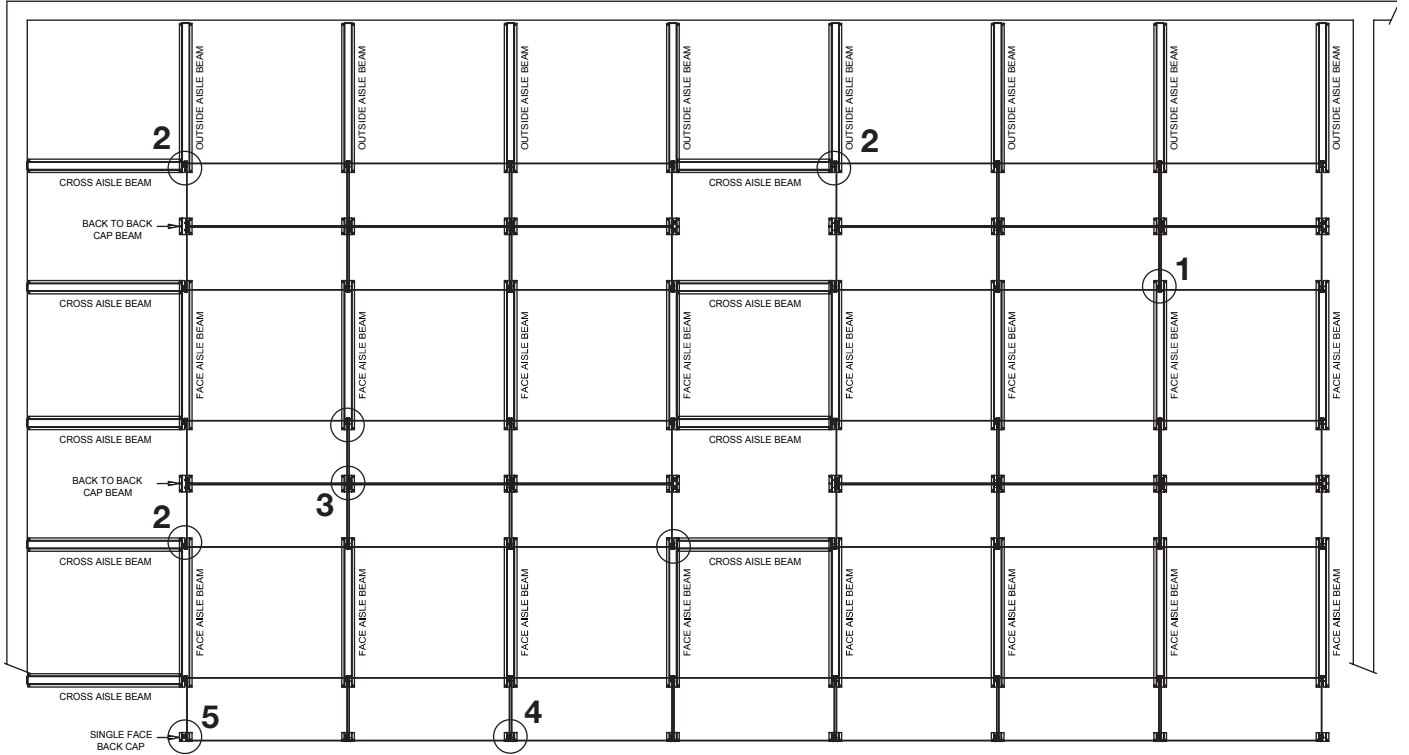

Portions of this publication reproduce figures/maps from the 1997 Uniform Building Code, Volume 2, International Code Council, Inc., Falls Church, Virginia. Reproduced with permission. All rights reserved.

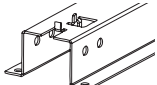
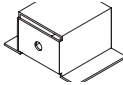
ICBO and/or ICC and Boroughs assume no responsibility for the accuracy or the completion of summaries provided herein.

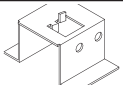
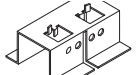

Catalog No.	Size	Wt. Each	Qty. Per Pack	List Price
	10409-000 36" x 1-7/8"	6.7	8	\$33.87
	10409-002 42" x 1-7/8"	7.8	8	\$35.70
	10409-003 48" x 1-7/8"	8.6	8	\$45.87
Cross Aisle Cap Beam				
	10408-000 42" x 1-7/8"	6.6	8	\$36.82
	10408-001 48" x 1-7/8"	8.6	8	\$39.24
	10408-002 36" x 1-7/8"	5.7	8	\$33.41
Outside Aisle Cap Beam				
	10457-000 36" x 1-7/8"	6.3	8	\$35.00
	10457-001 42" x 1-7/8"	7.2	8	\$38.85
	10457-002 48" x 1-7/8"	8.1	8	\$41.37
Single Face Back Cap				
	10418-000 1-7/8"	0.4	8	\$10.55
Back to Back Cap				
	10417-000 1-7/8"	0.7	4	\$14.78

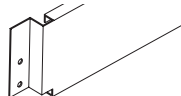
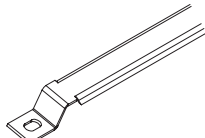
Catalog No.	Size	Wt. Each	Qty. Per Pack	List Price
Single Face Attachment Bracket				
	10455-000 -	0.1	4	\$6.06
Row End Corner Splice Channel				
	10415-000 -	0.4	8	\$6.80
Row End Kick Plate				
	10407-000 36"	6.4	8	\$40.78
	10407-001 42"	7.3	8	\$54.25
	10407-002 48"	8.3	8	\$67.54
Row End Hand Rail				
	10413-000 36"	2	8	\$38.96
	10413-001 42"	2.3	8	\$53.81
	10413-002 48"	2.7	8	\$67.06

HD DRAWERS, SIZES, AND SPECIFICATIONS

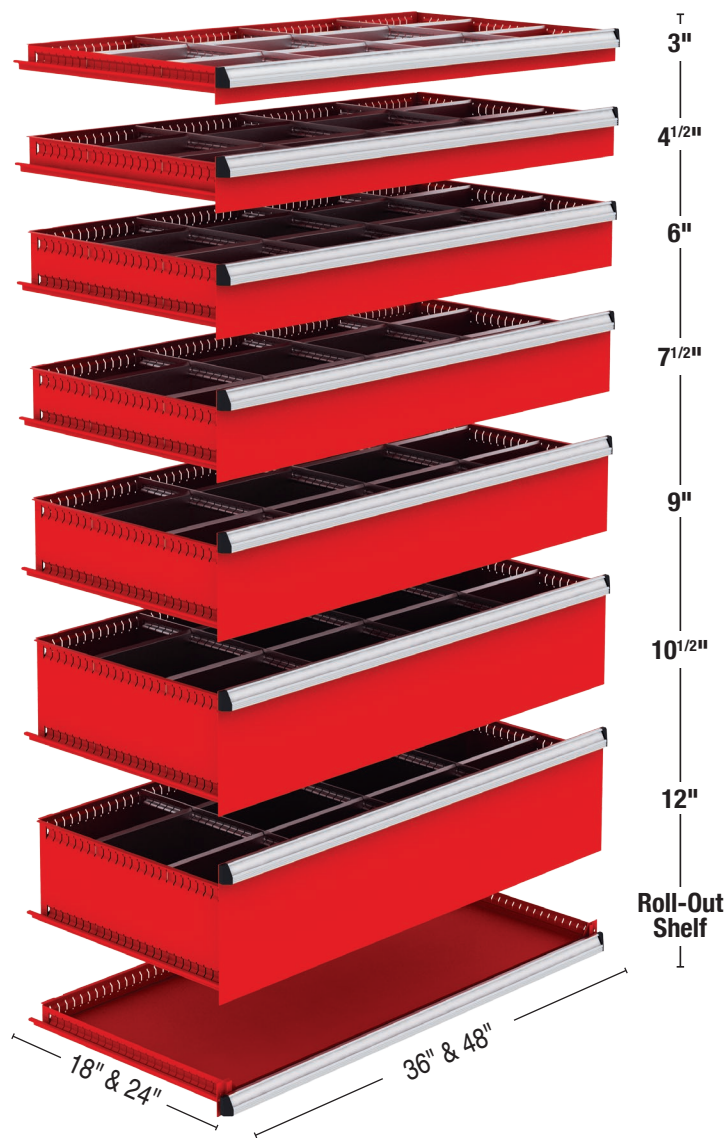

28 DRAWER SIZES

Drawers have 7 different heights: **3", 4¹/₂", 6", 7¹/₂", 9", 10¹/₂", 12"** and **Roll-Out Shelf**. Drawers can be arranged and rearranged to keep your storage system efficient as your operation grows and changes. They can be installed in any combination as long as the total height of the drawer fronts does not exceed the height of the mounting upright panels.

FEATURES

- Drawers fully extend to view and access entire contents.
- Roller bearing suspension for smooth operation.
- Each drawer will support up to 400 pounds of an evenly distributed load.
- Partitions and dividers can be added for custom configuration.
- All hardware and easy-to follow instructions are provided for fast installation.
- Drawer dividers and partitions are galvanized steel & factory installed.

HD DRAWER PARTITIONS & DIVIDERS

PARTITIONS



Galvanized, slotted steel partitions create major drawer interior storage spaces. Partitions slide into slots on drawer walls to span the full depth of drawers—and, allow the addition of dividers to further subdivide the drawer's interior.

DIVIDERS

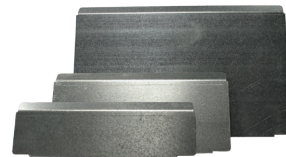

Galvanized steel dividers subdivide the storage spaces between partitions or partitions and drawer walls. Dividers simply drop into slots in partitions and drawer walls making storage space adjustments quick and easy. Slots in partitions and drawer walls are on 20mm (3/4" nominal) centers. Divider widths are measured by the number of drawer wall slots the divider spans (i.e. a 4s divider will span 4 slots). Dividers are available in heights to match partitions and in 17 widths (*refer to page 27*). The 36" wide drawer has 39 slots and the 48" wide drawer has 54 slots.

PRE-CONFIGURED DRAWER SYSTEM PART NUMBER LEGEND

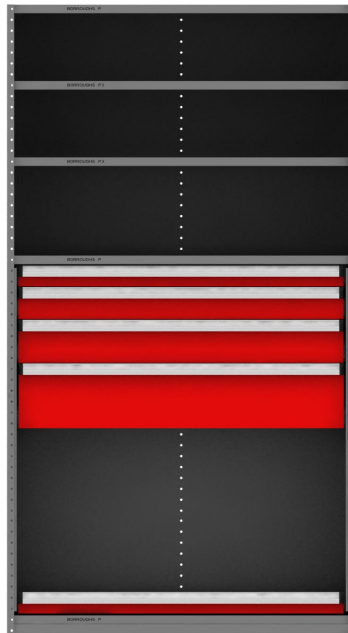

Shelving not included.

Pre-Configured units come with: Mounting Upright Panels, Drawers, Slides, Partitions and Dividers (partitions and dividers are factory installed).

PRODUCT MODEL

D1 - 48 24 48 - 05 A L

DRAWER WIDTH

OPTIONS = 36, 48

DRAWER DEPTH

OPTIONS = 18, 24

DRAWER QUANTITY

MUST BE TWO (2) DIGIT NUMBER

DRAWER CONFIGURATION

A PRE-DETERMINED LETTER THAT DEFINES A SPECIFIC GROUPING OF DRAWERS AND INTERIORS

FRAME HEIGHT	
OPTION	SIZE
06	6"
12	12"
18	18"
24	24"
36	36"
48	48"

DRAWER INTERIORS	
OPTION	DESCRIPTION
E	EMPTY DRAWERS
L	PRE-DETERMINED INTERIORS (DIVIDERS & PARTITIONS FACTORY INSTALLED)

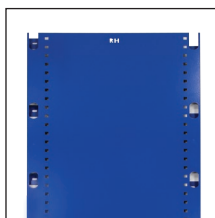

Mounting upright panel sets are available in 6 heights: **6", 12", 18", 24", 36" and 48"**.

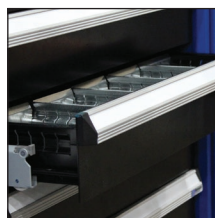

Full-width aluminum handle features integral label holder and paper insert. Handles are flush with shelving.



400 lb. capacity roller bearing slides offer smooth operation with full drawer extension.



Catalog No.	Size	# Of Drawers/ Compartments	Drawer Configuration	Wt. Each	List Price
D1-361818-04AL	36"W x 18"D x 18"H	4/96	(4) 4-1/2" 0604	128.67	\$1,598.35
D1-361818-04AE	36"W x 18"D x 18"H	4/Empty	(4) 4-1/2"	105.11	\$1,527.43
D1-361824-05AL	36"W x 18"D x 24"H	5/104	(4) 4-1/2" 0604 (1) 6" 1009	163.56	\$1,935.22
D1-361824-05AE	36"W x 18"D x 24"H	5/Empty	(4) 4-1/2" (1) 6"	135.54	\$1,530.23
D1-361836-07AL	36"W x 18"D x 36"H	7/120	(4) 4-1/2" 0604 (3) 6" 1009	233.32	\$2,657.72
D1-361836-07AE	36"W x 18"D x 36"H	7/Empty	(4) 4-1/2" (3) 6"	196.38	\$2,171.14
D1-361836-07BL	36"W x 18"D x 36"H	7/118	(2) 3" 0604 (2) 4-1/2" 0604 (2) 6" 1009 (1) 9" 1309	230.91	\$2,622.05
D1-361836-07BE	36"W x 18"D x 36"H	7/Empty	(2) 3" (2) 4-1/2" (2) 6" (1) 9"	196.46	\$2,174.29
D1-361848-08AL	36"W x 18"D x 48"H	8/64	(8) 6" 1009	280.14	\$2,849.26
D1-361848-08AE	36"W x 18"D x 48"H	8/Empty	(8) 6"	244.46	\$2,526.22
D1-361848-08BL	36"W x 18"D x 48"H	8/137	(3) 3" 0604 (2) 4-1/2" 0604 (2) 6" 1009 (1) Roll-Out @ bottom	260.64	\$2,885.94
D1-361848-08BE	36"W x 18"D x 48"H	8/Empty	(3) 3" (2) 4-1/2" (2) 6" (1) Roll-Out @ bottom	225.12	\$2,439.66
D1-361848-09AL	36"W x 18"D x 48"H	9/134	(2) 3" 0604 (2) 4-1/2" 0604 (4) 6" 1009 (1) 9" 1309	300.70	\$3,268.60
D1-361848-09AE	36"W x 18"D x 48"H	9/Empty	(2) 3" (2) 4-1/2" (4) 6" (1) 9"	257.33	\$2,784.40
D1-361848-10AL	36"W x 18"D x 48"H	10/176	(2) 3" 0604 (4) 4-1/2" 0604 (4) 6" 1009	325.06	\$3,652.12
D1-361848-10AE	36"W x 18"D x 48"H	10/Empty	(2) 3" (4) 4-1/2" (4) 6"	273.78	\$3,042.49
D1-361848-11AL	36"W x 18"D x 48"H	11/200	(5) 3" 0604 (2) 4-1/2" 0604 (4) 6" 1009	346.50	\$3,975.36
D1-361848-11AE	36"W x 18"D x 48"H	11/Empty	(5) 3" (2) 4-1/2" (4) 6"	292.18	\$3,306.85

- Part numbers include: drawer(s), slides, partitions and dividers (partitions & dividers - factory installed) & mounting uprights.
- Does not include shelves or closed sides.

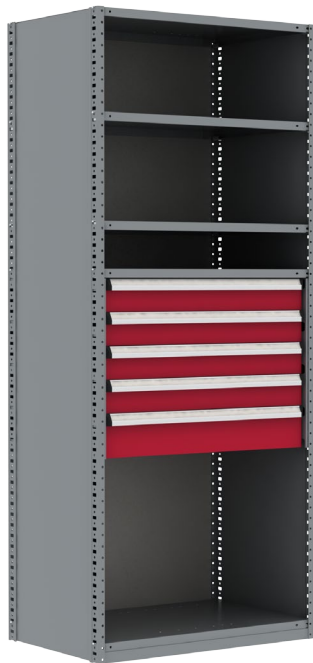

Catalog No.	Size	# Of Drawers/ Compartments	Drawer Configuration	Wt. Each	List Price
D1-362418-04AL	36"W x 24"D x 18"H	4/180	(4) 4-1/2" 0605	169.04	\$1,803.53
D1-362418-04AE	36"W x 24"D x 18"H	4/Empty	(4) 4-1/2"	129.56	\$1,382.52
D1-362424-05AL	36"W x 18"D x 24"H	5/192	(4) 4-1/2" 0605 (1) 6" 1008	213.38	\$2,125.15
D1-362424-05AE	36"W x 24"D x 24"H	5/Empty	(4) 4-1/2" (1) 6"	167.11	\$1,733.91
D1-362436-07AL	36"W x 24"D x 36"H	7/216	(4) 4-1/2" 0605 (3) 6" 1008	301.16	\$2,942.60
D1-362436-07AE	36"W x 24"D x 36"H	7/Empty	(4) 4-1/2" (3) 6"	241.31	\$2,450.98
D1-362436-07BL	36"W x 24"D x 36"H	7/153	(2) 3" 0605 (2) 4-1/2" 0605 (2) 6" 1008 (1) 9" 1308	294.47	\$2,903.38
D1-362436-07BE	36"W x 24"D x 36"H	7/Empty	(2) 3" (2) 4-1/2" (2) 6" (1) 9"	241.23	\$2,371.71
D1-362448-08AL	36"W x 24"D x 48"H	8/96	(8) 6" 1008	353.31	\$3,264.32
D1-362448-08AE	36"W x 24"D x 48"H	8/Empty	(8) 6"	298.99	\$2,862.77
D1-362448-08BL	36"W x 24"D x 48"H	8/175	(3) 3" 0605 (2) 4-1/2" 0605 (2) 6" 1008 (1) Roll-Out @ bottom	327.98	\$3,269.48
D1-362448-08BE	36"W x 24"D x 48"H	8/Empty	(3) 3" (2) 4-1/2" (2) 6" (1) Roll-Out @ bottom	273.75	\$2,675.37
D1-362448-09AL	36"W x 24"D x 48"H	9/177	(2) 3" 0605 (2) 4-1/2" 0605 (4) 6" 1008 (1) 9" 1308	382.54	\$3,705.44
D1-362448-09AE	36"W x 24"D x 48"H	9/Empty	(2) 3" (2) 4-1/2" (4) 6" (1) 9"	315.72	\$3,083.28
D1-362448-10AL	36"W x 24"D x 48"H	10/228	(2) 3" 0605 (4) 4-1/2" 0605 (4) 6" 1008	417.21	\$4,145.15
D1-362448-10AE	36"W x 24"D x 48"H	10/Empty	(2) 3" (4) 4-1/2" (4) 6"	336.63	\$3,387.87
D1-362448-11AL	36"W x 24"D x 48"H	11/258	(5) 3" 0605 (2) 4-1/2" 0605 (4) 6" 1008	441.22	\$4,505.73
D1-362448-11AE	36"W x 24"D x 48"H	11/Empty	(5) 3" (2) 4-1/2" (4) 6"	359.47	\$3,595.77

- Part numbers include: drawer(s), slides, partitions and dividers (partitions & dividers - factory installed) & mounting uprights.
- Does not include shelves or closed sides.

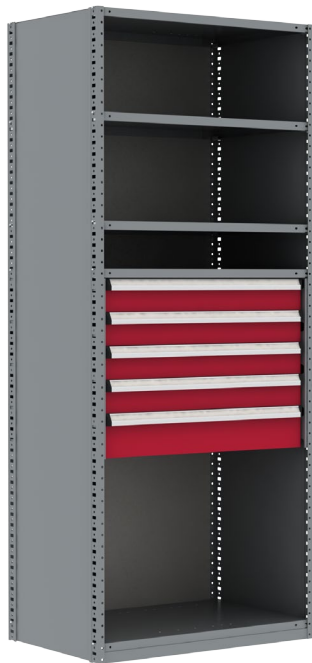

Catalog No.	Size	# Of Drawers/ Compartments	Drawer Configuration	Wt. Each	List Price
D1-481818-04AL	48"W x 18"D x 18"H	4/128	(4) 4-1/2" 0704	146.31	\$1,750.27
D1-481818-04AE	48"W x 18"D x 18"H	4/Empty	(4) 4-1/2"	113.59	\$1,307.59
D1-481824-05AL	48"W x 18"D x 24"H	5/138	(4) 4-1/2" 0704 (1) 6" 1109	184.45	\$2,136.53
D1-481824-05AE	48"W x 18"D x 24"H	5/Empty	(4) 4-1/2" (1) 6"	145.73	\$1,639.01
D1-481836-07AL	48"W x 18"D x 36"H	7/158	(4) 4-1/2" 0704 (3) 6" 1109	260.71	\$2,931.06
D1-481836-07AE	48"W x 18"D x 36"H	7/Empty	(4) 4-1/2" (3) 6"	209.99	\$2,326.82
D1-481836-07BL	48"W x 18"D x 36"H	7/156	(2) 3" 0704 (2) 4-1/2" 0704 (2) 6" 1109 (1) 9" 1309	258.08	\$2,905.23
D1-481836-07BE	48"W x 18"D x 36"H	7/Empty	(2) 3" (2) 4-1/2" (2) 6" (1) 9"	210.28	\$2,336.90
D1-481848-08AL	48"W x 18"D x 48"H	8/80	(8) 6" 1109	306.14	\$3,140.72
D1-481848-08AE	48"W x 18"D x 48"H	8/Empty	(8) 6"	258.14	\$2,709.87
D1-481848-08BL	48"W x 18"D x 48"H	8/181	(3) 3" 0704 (2) 4-1/2" 0704 (2) 6" 1109 (1) Roll-Out @ bottom	299.09	\$3,246.75
D1-481848-08BE	48"W x 18"D x 48"H	8/Empty	(3) 3" (2) 4-1/2" (2) 6" (1) Roll-Out @ bottom	250.18	\$2,620.81
D1-481848-09AL	48"W x 18"D x 48"H	9/176	(2) 3" 0704 (2) 4-1/2" 0704 (4) 6" 1109 (1) 9" 1309	334.37	\$3,668.96
D1-481848-09AE	48"W x 18"D x 48"H	9/Empty	(2) 3" (2) 4-1/2" (4) 6" (1) 9"	274.57	\$2,992.91
D1-481848-10AL	48"W x 18"D x 48"H	10/232	(2) 3" 0704 (4) 4-1/2" 0704 (4) 6" 1109	364.24	\$4,126.40
D1-481848-10AE	48"W x 18"D x 48"H	10/Empty	(2) 3" (4) 4-1/2" (4) 6"	293.82	\$3,270.37
D1-481848-11AL	48"W x 18"D x 48"H	11/264	(5) 3" 0704 (2) 4-1/2" 0704 (4) 6" 1109	389.67	\$4,496.77
D1-481848-11AE	48"W x 18"D x 48"H	11/Empty	(5) 3" (2) 4-1/2" (4) 6"	315.06	\$3,565.18

- Part numbers include: drawer(s), slides, partitions and dividers (partitions & dividers - factory installed) & mounting uprights.
- Does not include shelves or closed sides.

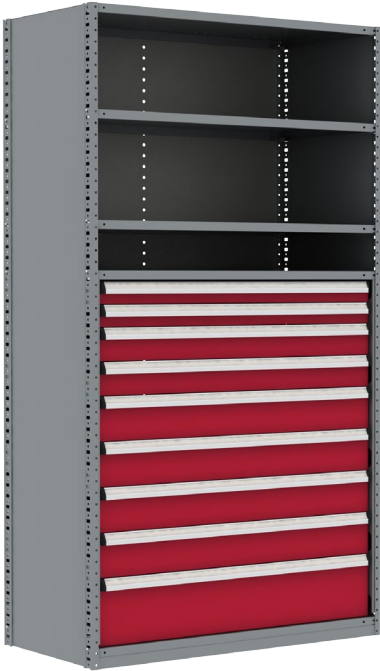

Catalog No.	Size	# Of Drawers/ Compartments	Drawer Configuration	Wt. Each	List Price
D1-482418-04AL	48"W x 24"D x 18"H	4/160	(4) 4-1/2" 0705	186.60	\$1,953.25
D1-482418-04AE	48"W x 24"D x 18"H	4/Empty	(4) 4-1/2"	142.32	\$1,220.78
D1-482424-05AL	48"W x 18"D x 24"H	5/175	(4) 4-1/2" 0705 (1) 6" 1108	235.53	\$2,396.91
D1-482424-05AE	48"W x 24"D x 24"H	5/Empty	(4) 4-1/2" (1) 6"	182.65	\$1,530.23
D1-482436-07AL	48"W x 24"D x 36"H	7/205	(4) 4-1/2" 0705 (3) 6" 1108	332.49	\$3,298.51
D1-482436-07AE	48"W x 24"D x 36"H	7/Empty	(4) 4-1/2" (3) 6"	262.41	\$2,171.14
D1-482436-07BL	48"W x 24"D x 36"H	7/198	(2) 3" 0705 (2) 4-1/2" 0705 (2) 6" 1108 (1) 9" 1313	327.63	\$3,269.60
D1-482436-07BE	48"W x 24"D x 36"H	7/Empty	(2) 3" (2) 4-1/2" (2) 6" (1) 9"	262.54	\$2,174.29
D1-482448-08AL	48"W x 24"D x 48"H	8/120	(8) 6" 1108	390.03	\$3,600.92
D1-482448-08AE	48"W x 24"D x 48"H	8/Empty	(8) 6"	321.23	\$2,526.22
D1-482448-08BL	48"W x 24"D x 48"H	8/231	(3) 3" 0705 (2) 4-1/2" 0705 (2) 6" 1108 (1) Roll-Out @ bottom	374.08	\$3,670.69
D1-482448-08BE	48"W x 24"D x 48"H	8/Empty	(3) 3" (2) 4-1/2" (2) 6" (1) Roll-Out @ bottom	307.20	\$2,439.66
D1-482448-09AL	48"W x 24"D x 48"H	9/228	(2) 3" 0705 (2) 4-1/2" 0705 (4) 6" 1108 (1) 9" 1313	424.88	\$4,155.80
D1-482448-09AE	48"W x 24"D x 48"H	9/Empty	(2) 3" (2) 4-1/2" (4) 6" (1) 9"	342.59	\$2,784.40
D1-482448-10AL	48"W x 24"D x 48"H	10/300	(2) 3" 0705 (4) 4-1/2" 0705 (4) 6" 1108	464.41	\$4,664.46
D1-482448-10AE	48"W x 24"D x 48"H	10/Empty	(2) 3" (4) 4-1/2" (4) 6"	367.37	\$3,042.49
D1-482448-11AL	48"W x 24"D x 48"H	11/340	(5) 3" 0705 (2) 4-1/2" 0705 (4) 6" 1108	496.56	\$3,975.36
D1-482448-11AE	48"W x 24"D x 48"H	11/Empty	(5) 3" (2) 4-1/2" (4) 6"	394.12	\$3,306.85

- Part numbers include: drawer(s), slides, partitions and dividers (partitions & dividers - factory installed) & mounting uprights.
- Does not include shelves or closed sides.

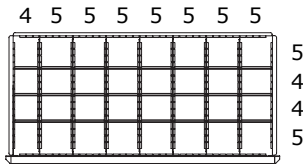

40 Compartments

Catalog No.	Size	Wt. Each	Price
D1-3618030-0504	3"	27.17	\$371.73
D1-3618045-0504	4-1/2"	29.82	\$383.22
D1-3618060-0504	6"	36.37	\$400.56
D1-3618075-0504	7-1/2"	36.85	\$488.70
D1-3618090-0504	9"	41.47	\$505.05
D1-3618105-0504	10-1/2"	49.78	\$529.09
D1-3618120-0504	12"	49.78	\$541.65

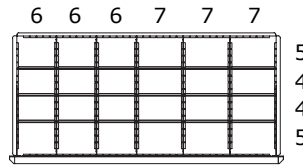

24 Compartments

Catalog No.	Size	Wt. Each	Price
D1-3618030-0604	3"	25.98	\$350.03
D1-3618045-0604	4-1/2"	28.25	\$363.43
D1-3618060-0604	6"	33.84	\$380.23
D1-3618075-0604	7-1/2"	34.32	\$437.63
D1-3618090-0604	9"	38.26	\$451.70
D1-3618105-0604	10-1/2"	45.27	\$473.25
D1-3618120-0604	12"	45.27	\$485.81

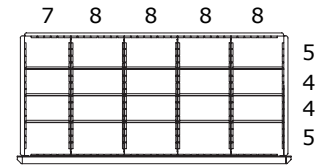

20 Compartments

Catalog No.	Size	Wt. Each	Price
D1-3618030-0804	3"	25.37	\$347.47
D1-3618045-0804	4-1/2"	27.45	\$362.84
D1-3618060-0804	6"	32.56	\$373.51
D1-3618075-0804	7-1/2"	33.04	\$411.98
D1-3618090-0804	9"	36.64	\$425.37
D1-3618105-0804	10-1/2"	43.00	\$445.13
D1-3618120-0804	12"	43.00	\$457.68

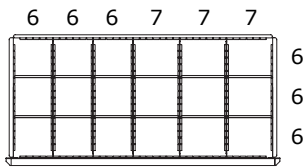

18 Compartments

Catalog No.	Size	Wt. Each	Price
D1-3618030-0606	3"	25.35	\$340.76
D1-3618045-0606	4-1/2"	27.62	\$353.07
D1-3618060-0606	6"	33.21	\$367.05
D1-3618075-0606	7-1/2"	33.69	\$415.40
D1-3618090-0606	9"	37.63	\$428.08
D1-3618105-0606	10-1/2"	44.64	\$447.55
D1-3618120-0606	12"	44.64	\$460.11

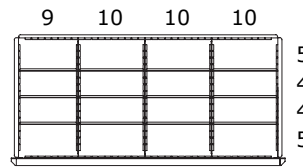

16 Compartments

Catalog No.	Size	Wt. Each	Price
D1-3618030-1004	3"	24.73	\$334.87
D1-3618045-1004	4-1/2"	26.62	\$348.46
D1-3618060-1004	6"	31.25	\$358.43
D1-3618075-1004	7-1/2"	31.73	\$386.42
D1-3618090-1004	9"	34.99	\$399.61
D1-3618105-1004	10-1/2"	40.70	\$417.43
D1-3618120-1004	12"	40.70	\$429.99

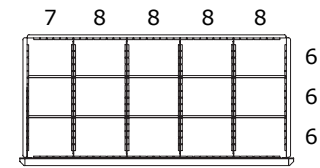

15 Compartments

Catalog No.	Size	Wt. Each	Price
D1-3618030-0806	3"	24.74	\$329.09
D1-3618045-0806	4-1/2"	26.82	\$340.65
D1-3618060-0806	6"	31.93	\$354.28
D1-3618075-0806	7-1/2"	32.41	\$392.73
D1-3618090-0806	9"	36.01	\$404.66
D1-3618105-0806	10-1/2"	42.37	\$422.39
D1-3618120-0806	12"	42.37	\$434.95

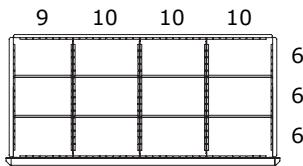

12 Compartments

Catalog No.	Size	Wt. Each	Price
D1-3618030-1006	3"	24.11	\$318.60
D1-3618045-1006	4-1/2"	26.00	\$331.78
D1-3618060-1006	6"	30.63	\$351.90
D1-3618075-1006	7-1/2"	31.11	\$370.11
D1-3618090-1006	9"	34.37	\$381.61
D1-3618105-1006	10-1/2"	40.08	\$397.52
D1-3618120-1006	12"	40.08	\$410.07

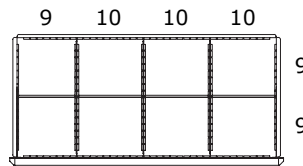

8 Compartments

Catalog No.	Size	Wt. Each	Price
D1-3618030-1009	3"	23.49	\$314.97
D1-3618045-1009	4-1/2"	25.38	\$325.26
D1-3618060-1009	6"	30.01	\$337.73
D1-3618075-1009	7-1/2"	30.49	\$353.80
D1-3618090-1009	9"	33.75	\$363.62
D1-3618105-1009	10-1/2"	39.46	\$377.60
D1-3618120-1009	12"	39.46	\$390.16

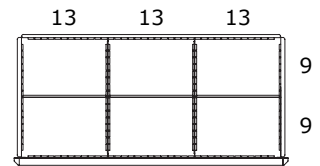

6 Compartments

Catalog No.	Size	Wt. Each	Price
D1-3618030-1309	3"	22.89	\$303.61
D1-3618045-1309	4-1/2"	24.59	\$313.13
D1-3618060-1309	6"	28.74	\$325.25
D1-3618075-1309	7-1/2"	29.22	\$334.26
D1-3618090-1309	9"	32.14	\$343.19
D1-3618105-1309	10-1/2"	37.20	\$355.38
D1-3618120-1309	12"	37.20	\$367.94

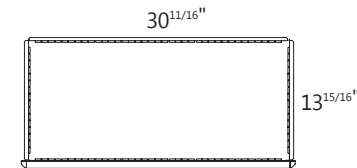

1 Compartment

Catalog No.	Size	Wt. Each	Price
D1-3618030-0000	3"	21.04	\$279.30
D1-3618045-0000	4-1/2"	22.36	\$286.77
D1-3618060-0000	6"	25.55	\$297.35
D1-3618075-0000	7-1/2"	26.03	\$308.68
D1-3618090-0000	9"	28.27	\$292.79
D1-3618105-0000	10-1/2"	32.03	\$300.00
D1-3618120-0000	12"	32.03	\$312.56

- Part numbers include: drawer(s), slides, partitions and dividers (partitions & dividers - factory installed).

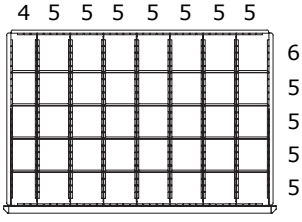

40 Compartments

Catalog No.	Size	Wt. Each	Price
D1-3624030-0505	3"	34.67	\$458.01
D1-3624045-0505	4-1/2"	40.29	\$480.93
D1-3624060-0505	6"	46.52	\$519.22
D1-3624075-0505	7-1/2"	47.00	\$553.17
D1-3624090-0505	9"	53.13	\$574.65
D1-3624105-0505	10-1/2"	68.21	\$604.95
D1-3624120-0505	12"	63.80	\$622.50

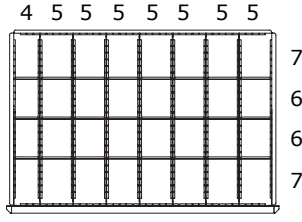

32 Compartments

Catalog No.	Size	Wt. Each	Price
D1-3624030-0506	3"	34.05	\$431.34
D1-3624045-0506	4-1/2"	39.67	\$454.79
D1-3624060-0506	6"	45.90	\$491.11
D1-3624075-0506	7-1/2"	46.38	\$525.06
D1-3624090-0506	9"	52.51	\$545.00
D1-3624105-0506	10-1/2"	67.59	\$573.46
D1-3624120-0506	12"	63.18	\$591.00

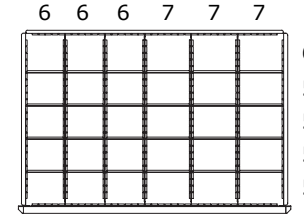

30 Compartments

Catalog No.	Size	Wt. Each	Price
D1-3624030-0605	3"	32.93	\$402.83
D1-3624045-0605	4-1/2"	37.39	\$426.31
D1-3624060-0605	6"	42.86	\$459.19
D1-3624075-0605	7-1/2"	43.34	\$493.14
D1-3624090-0605	9"	48.45	\$511.13
D1-3624105-0605	10-1/2"	60.41	\$537.48
D1-3624120-0605	12"	57.26	\$555.03

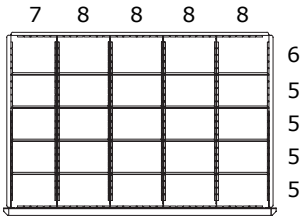

25 Compartments

Catalog No.	Size	Wt. Each	Price
D1-3624030-0805	3"	32.04	\$375.04
D1-3624045-0805	4-1/2"	35.92	\$399.41
D1-3624060-0805	6"	41.01	\$429.02
D1-3624075-0805	7-1/2"	41.49	\$462.97
D1-3624090-0805	9"	46.09	\$479.83
D1-3624105-0805	10-1/2"	56.49	\$503.47
D1-3624120-0805	12"	53.97	\$521.02

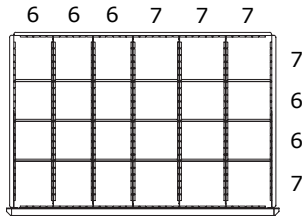

24 Compartments

Catalog No.	Size	Wt. Each	Price
D1-3624030-0606	3"	32.30	\$382.84
D1-3624045-0606	4-1/2"	36.76	\$406.05
D1-3624060-0606	6"	42.23	\$436.96
D1-3624075-0606	7-1/2"	42.71	\$470.91
D1-3624090-0606	9"	47.82	\$487.52
D1-3624105-0606	10-1/2"	59.78	\$511.78
D1-3624120-0606	12"	56.63	\$529.32

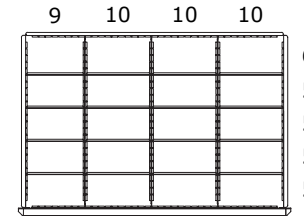

20 Compartments

Catalog No.	Size	Wt. Each	Price
D1-3624030-1005	3"	31.11	\$351.18
D1-3624045-1005	4-1/2"	34.41	\$372.37
D1-3624060-1005	6"	39.12	\$398.97
D1-3624075-1005	7-1/2"	39.60	\$432.92
D1-3624090-1005	9"	43.69	\$449.47
D1-3624105-1005	10-1/2"	52.53	\$470.03
D1-3624120-1005	12"	50.64	\$487.58

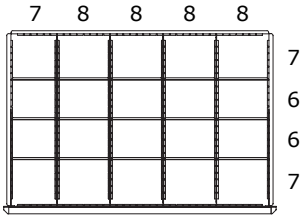

20 Compartments

Catalog No.	Size	Wt. Each	Price
D1-3624030-0806	3"	31.41	\$358.45
D1-3624045-0806	4-1/2"	35.29	\$381.99
D1-3624060-0806	6"	40.38	\$409.77
D1-3624075-0806	7-1/2"	40.86	\$443.72
D1-3624090-0806	9"	45.46	\$459.12
D1-3624105-0806	10-1/2"	55.86	\$480.73
D1-3624120-0806	12"	53.34	\$498.28

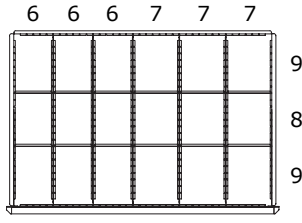

18 Compartments

Catalog No.	Size	Wt. Each	Price
D1-3624030-0608	3"	31.67	\$362.86
D1-3624045-0608	4-1/2"	36.13	\$385.80
D1-3624060-0608	6"	41.60	\$414.73
D1-3624075-0608	7-1/2"	42.08	\$448.68
D1-3624090-0608	9"	47.19	\$463.90
D1-3624105-0608	10-1/2"	59.15	\$486.07
D1-3624120-0608	12"	56.00	\$503.62

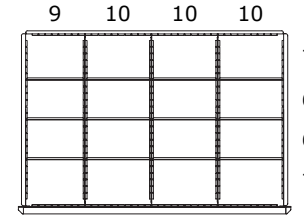

16 Compartments

Catalog No.	Size	Wt. Each	Price
D1-3624030-1006	3"	30.49	\$336.99
D1-3624045-1006	4-1/2"	33.79	\$357.83
D1-3624060-1006	6"	38.50	\$382.66
D1-3624075-1006	7-1/2"	38.98	\$416.62
D1-3624090-1006	9"	43.07	\$431.29
D1-3624105-1006	10-1/2"	51.91	\$450.12
D1-3624120-1006	12"	50.02	\$467.66

• Part numbers include: drawer(s), slides, partitions and dividers (partitions & dividers - factory installed).

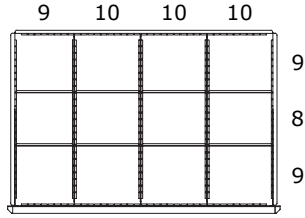

12 Compartments

Catalog No.	Size	Wt. Each	Price
D1-3624030-1008	3"	29.87	\$361.94
D1-3624045-1008	4-1/2"	33.17	\$343.30
D1-3624060-1008	6"	37.88	\$366.35
D1-3624075-1008	7-1/2"	38.36	\$400.31
D1-3624090-1008	9"	42.45	\$413.30
D1-3624105-1008	10-1/2"	51.29	\$430.20
D1-3624120-1008	12"	49.40	\$447.75

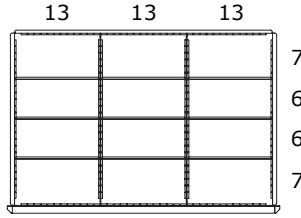

12 Compartments

Catalog No.	Size	Wt. Each	Price
D1-3624030-1306	3"	29.63	\$351.19
D1-3624045-1306	4-1/2"	32.35	\$333.78
D1-3624060-1306	6"	36.68	\$355.95
D1-3624075-1306	7-1/2"	37.16	\$389.90
D1-3624090-1306	9"	40.74	\$403.15
D1-3624105-1306	10-1/2"	48.02	\$418.99
D1-3624120-1306	12"	46.76	\$436.54

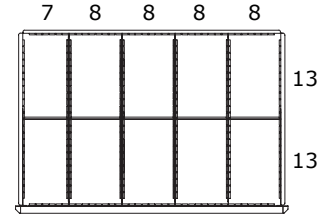

10 Compartments

Catalog No.	Size	Wt. Each	Price
D1-3624030-0813	3"	30.15	\$372.13
D1-3624045-0813	4-1/2"	34.03	\$385.45
D1-3624060-0813	6"	39.12	\$371.26
D1-3624075-0813	7-1/2"	39.60	\$405.21
D1-3624090-0813	9"	44.20	\$417.71
D1-3624105-0813	10-1/2"	54.60	\$435.26
D1-3624120-0813	12"	52.08	\$452.81

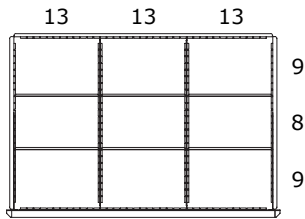

9 Compartments

Catalog No.	Size	Wt. Each	Price
D1-3624030-1308	3"	29.00	\$349.02
D1-3624045-1308	4-1/2"	31.72	\$359.05
D1-3624060-1308	6"	36.05	\$342.46
D1-3624075-1308	7-1/2"	36.53	\$380.82
D1-3624090-1308	9"	40.11	\$387.98
D1-3624105-1308	10-1/2"	47.39	\$402.07
D1-3624120-1308	12"	46.13	\$414.10

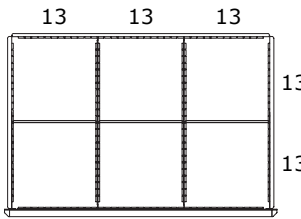

6 Compartments

Catalog No.	Size	Wt. Each	Price
D1-3624030-1313	3"	28.37	\$346.86
D1-3624045-1313	4-1/2"	31.09	\$356.40
D1-3624060-1313	6"	35.42	\$367.90
D1-3624075-1313	7-1/2"	35.90	\$362.92
D1-3624090-1313	9"	39.48	\$372.81
D1-3624105-1313	10-1/2"	46.76	\$385.15
D1-3624120-1313	12"	45.50	\$407.30

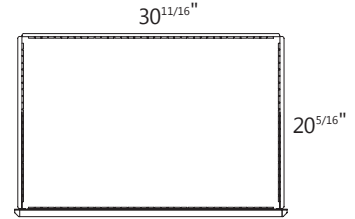

1 Compartment

Catalog No.	Size	Wt. Each	Price
D1-3624030-0000	3"	25.96	\$286.15
D1-3624045-0000	4-1/2"	27.52	\$325.28
D1-3624060-0000	6"	31.09	\$337.08
D1-3624075-0000	7-1/2"	31.57	\$312.89
D1-3624090-0000	9"	34.13	\$318.28
D1-3624105-0000	10-1/2"	38.29	\$323.93
D1-3624120-0000	12"	38.29	\$341.48

- Part numbers include: drawer(s), slides, partitions and dividers (partitions & dividers - factory installed).

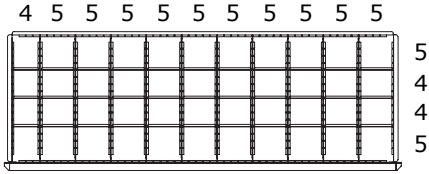

44 Compartments

Catalog No.	Size	Wt. Each	Price
D1-4818030-0504	3"	32.08	\$429.61
D1-4818045-0504	4-1/2"	35.06	\$441.35
D1-4818060-0504	6"	42.64	\$462.57
D1-4818075-0504	7-1/2"	43.31	\$475.11
D1-4818090-0504	9"	48.49	\$481.76
D1-4818105-0504	10-1/2"	57.89	\$522.37
D1-4818120-0504	12"	57.89	\$525.13

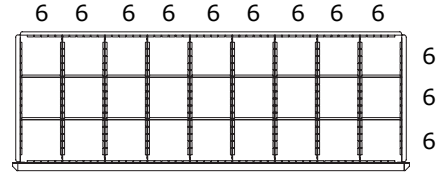

36 Compartments

Catalog No.	Size	Wt. Each	Price
D1-4818030-0606	3"	30.08	\$418.72
D1-4818045-0606	4-1/2"	32.68	\$433.59
D1-4818060-0606	6"	39.30	\$458.48
D1-4818075-0606	7-1/2"	39.97	\$464.03
D1-4818090-0606	9"	44.47	\$480.40
D1-4818105-0606	10-1/2"	52.57	\$509.84
D1-4818120-0606	12"	52.57	\$513.01

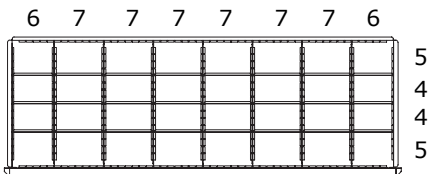

32 Compartments

Catalog No.	Size	Wt. Each	Price
D1-4818030-0704	3"	30.25	\$402.89
D1-4818045-0704	4-1/2"	32.66	\$419.14
D1-4818060-0704	6"	38.80	\$441.51
D1-4818075-0704	7-1/2"	39.47	\$445.46
D1-4818090-0704	9"	43.63	\$461.29
D1-4818105-0704	10-1/2"	51.08	\$490.13
D1-4818120-0704	12"	51.08	\$493.12

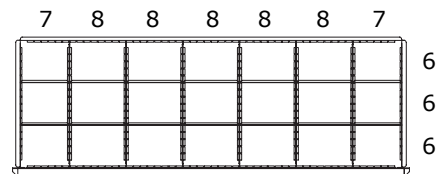

21 Compartments

Catalog No.	Size	Wt. Each	Price
D1-4818030-0806	3"	30.25	\$377.98
D1-4818045-0806	4-1/2"	32.66	\$388.55
D1-4818060-0806	6"	38.80	\$404.76
D1-4818075-0806	7-1/2"	39.47	\$413.35
D1-4818090-0806	9"	43.63	\$423.94
D1-4818105-0806	10-1/2"	51.08	\$453.18
D1-4818120-0806	12"	51.08	\$456.29

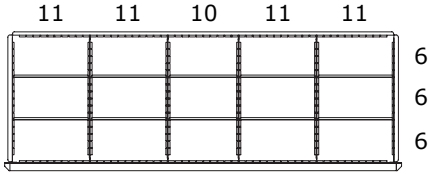

15 Compartments

Catalog No.	Size	Wt. Each	Price
D1-4818030-1106	3"	27.60	\$353.91
D1-4818045-1106	4-1/2"	29.44	\$369.70
D1-4818060-1106	6"	34.14	\$382.27
D1-4818075-1106	7-1/2"	34.81	\$391.74
D1-4818090-1106	9"	37.95	\$405.25
D1-4818105-1106	10-1/2"	43.45	\$429.75
D1-4818120-1106	12"	43.45	\$433.03

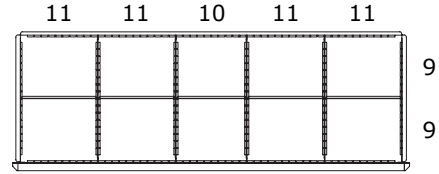

10 Compartments

Catalog No.	Size	Wt. Each	Price
D1-4818030-1109	3"	26.72	\$351.44
D1-4818045-1109	4-1/2"	28.56	\$359.78
D1-4818060-1109	6"	33.26	\$374.17
D1-4818075-1109	7-1/2"	33.93	\$383.92
D1-4818090-1109	9"	37.07	\$393.58
D1-4818105-1109	10-1/2"	42.57	\$418.03
D1-4818120-1109	12"	42.57	\$421.42

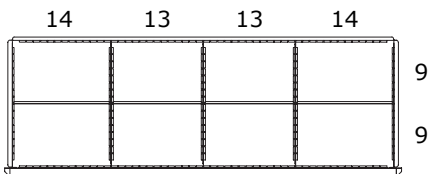

8 Compartments

Catalog No.	Size	Wt. Each	Price
D1-4818030-1309	3"	26.11	\$340.07
D1-4818045-1309	4-1/2"	27.76	\$347.64
D1-4818060-1309	6"	31.98	\$361.68
D1-4818075-1309	7-1/2"	32.65	\$369.97
D1-4818090-1309	9"	35.45	\$380.85
D1-4818105-1309	10-1/2"	40.30	\$401.77
D1-4818120-1309	12"	40.30	\$405.22

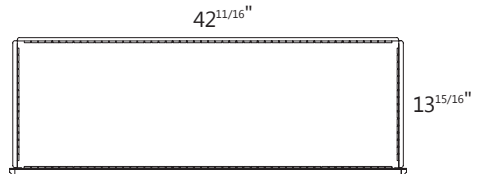

1 Compartment

Catalog No.	Size	Wt. Each	Price
D1-4818030-0000	3"	23.40	\$303.92
D1-4818045-0000	4-1/2"	24.48	\$308.47
D1-4818060-0000	6"	27.26	\$320.31
D1-4818075-0000	7-1/2"	27.93	\$328.91
D1-4818090-0000	9"	29.71	\$339.49
D1-4818105-0000	10-1/2"	32.61	\$349.91
D1-4818120-0000	12"	32.61	\$353.05

- Part numbers include: drawer(s), slides, partitions and dividers (partitions & dividers - factory installed).

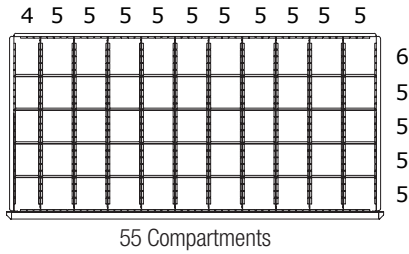

Catalog No.	Size	Wt. Each	Price
D1-4824030-0505	3"	41.03	\$484.83
D1-4824045-0505	4-1/2"	45.05	\$515.43
D1-4824060-0505	6"	54.41	\$531.53
D1-4824075-0505	7-1/2"	55.08	\$542.21
D1-4824090-0505	9"	61.78	\$549.01
D1-4824105-0505	10-1/2"	71.07	\$602.05
D1-4824120-0505	12"	71.07	\$604.87

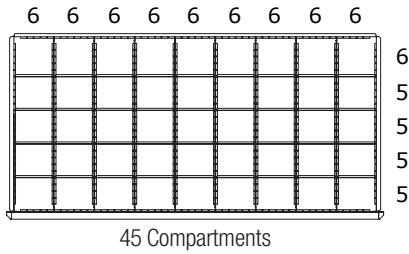

Catalog No.	Size	Wt. Each	Price
D1-4824030-0605	3"	39.55	\$457.82
D1-4824045-0605	4-1/2"	43.03	\$484.66
D1-4824060-0605	6"	51.15	\$500.86
D1-4824075-0605	7-1/2"	51.82	\$512.15
D1-4824090-0605	9"	57.60	\$518.33
D1-4824105-0605	10-1/2"	65.69	\$570.08
D1-4824120-0605	12"	65.69	\$573.01

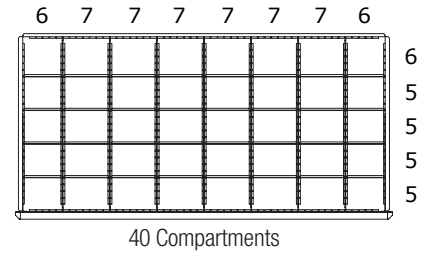

Catalog No.	Size	Wt. Each	Price
D1-4824030-0705	3"	38.57	\$454.55
D1-4824045-0705	4-1/2"	41.78	\$467.96
D1-4824060-0705	6"	49.28	\$494.17
D1-4824075-0705	7-1/2"	49.95	\$496.32
D1-4824090-0705	9"	55.27	\$516.67
D1-4824105-0705	10-1/2"	62.78	\$551.03
D1-4824120-0705	12"	62.78	\$554.03

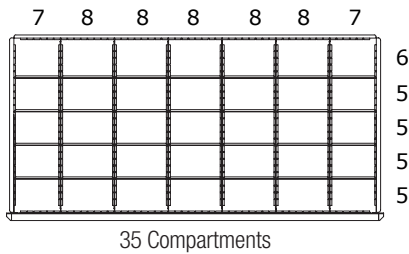

Catalog No.	Size	Wt. Each	Price
D1-4824030-0805	3"	37.79	\$430.77
D1-4824045-0805	4-1/2"	40.73	\$453.88
D1-4824060-0805	6"	47.61	\$470.17
D1-4824075-0805	7-1/2"	48.28	\$478.63
D1-4824090-0805	9"	53.14	\$487.54
D1-4824105-0805	10-1/2"	60.03	\$531.83
D1-4824120-0805	12"	60.03	\$534.88

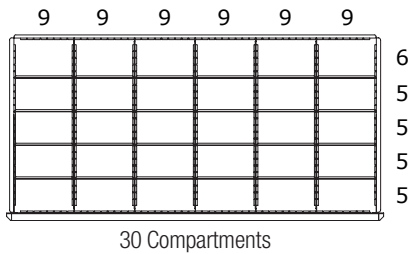

Catalog No.	Size	Wt. Each	Price
D1-4824030-0905	3"	36.85	\$417.26
D1-4824045-0905	4-1/2"	39.52	\$438.48
D1-4824060-0905	6"	45.78	\$454.82
D1-4824075-0905	7-1/2"	46.45	\$468.84
D1-4824090-0905	9"	50.85	\$472.29
D1-4824105-0905	10-1/2"	57.14	\$520.66
D1-4824120-0905	12"	57.14	\$523.83

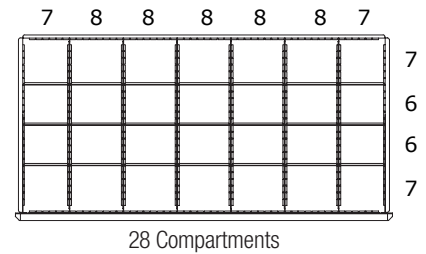

Catalog No.	Size	Wt. Each	Price
D1-4824030-0806	3"	36.92	\$426.95
D1-4824045-0806	4-1/2"	39.86	\$449.39
D1-4824060-0806	6"	46.74	\$464.54
D1-4824075-0806	7-1/2"	47.41	\$471.01
D1-4824090-0806	9"	52.27	\$482.02
D1-4824105-0806	10-1/2"	59.16	\$521.74
D1-4824120-0806	12"	59.16	\$524.90

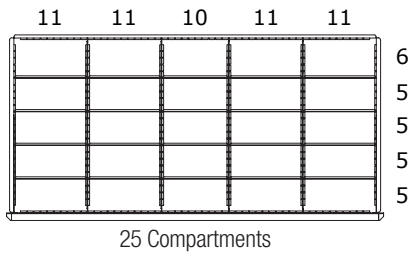

Catalog No.	Size	Wt. Each	Price
D1-4824030-1105	3"	36.19	\$403.74
D1-4824045-1105	4-1/2"	38.59	\$423.07
D1-4824060-1105	6"	44.23	\$439.46
D1-4824075-1105	7-1/2"	44.90	\$449.12
D1-4824090-1105	9"	48.84	\$456.93
D1-4824105-1105	10-1/2"	54.53	\$500.86
D1-4824120-1105	12"	54.53	\$503.89

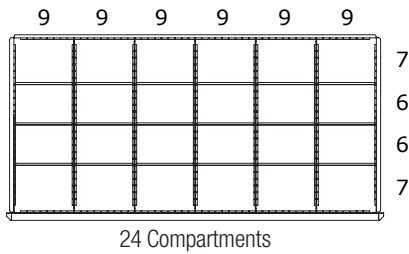

Catalog No.	Size	Wt. Each	Price
D1-4824030-0906	3"	36.01	\$413.74
D1-4824045-0906	4-1/2"	38.68	\$434.29
D1-4824060-0906	6"	44.94	\$449.47
D1-4824075-0906	7-1/2"	45.61	\$462.18
D1-4824090-0906	9"	50.01	\$466.94
D1-4824105-0906	10-1/2"	56.30	\$511.32
D1-4824120-0906	12"	56.30	\$514.60

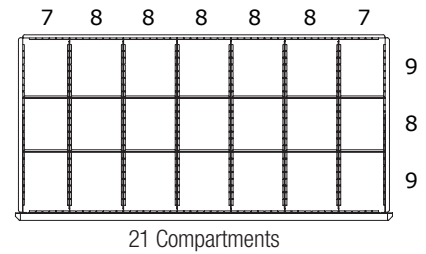

Catalog No.	Size	Wt. Each	Price
D1-4824030-0808	3"	36.05	\$423.15
D1-4824045-0808	4-1/2"	38.99	\$444.92
D1-4824060-0808	6"	45.87	\$458.92
D1-4824075-0808	7-1/2"	46.54	\$469.62
D1-4824090-0808	9"	51.40	\$476.39
D1-4824105-0808	10-1/2"	58.29	\$518.39
D1-4824120-0808	12"	58.29	\$521.73

- Part numbers include: drawer(s), slides, partitions and dividers (partitions & dividers - factory installed).

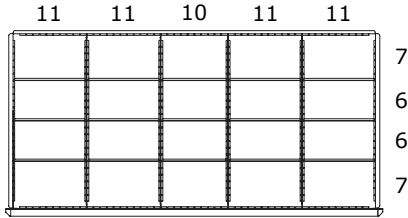

20 Compartments

Catalog No.	Size	Wt. Each	Price
D1-4824030-1106	3"	35.31	\$400.52
D1-4824045-1106	4-1/2"	37.71	\$419.18
D1-4824060-1106	6"	43.35	\$434.40
D1-4824075-1106	7-1/2"	44.02	\$443.93
D1-4824090-1106	9"	47.96	\$451.87
D1-4824105-1106	10-1/2"	53.65	\$492.21
D1-4824120-1106	12"	53.65	\$495.55

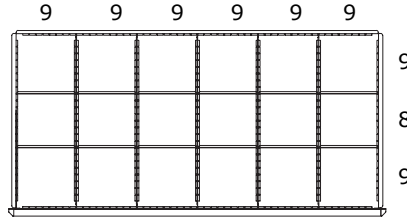

18 Compartments

Catalog No.	Size	Wt. Each	Price
D1-4824030-0908	3"	35.17	\$410.22
D1-4824045-0908	4-1/2"	37.84	\$430.10
D1-4824060-0908	6"	44.10	\$444.14
D1-4824075-0908	7-1/2"	44.02	\$459.27
D1-4824090-0908	9"	49.17	\$461.60
D1-4824105-0908	10-1/2"	53.65	\$509.18
D1-4824120-0908	12"	53.65	\$512.63

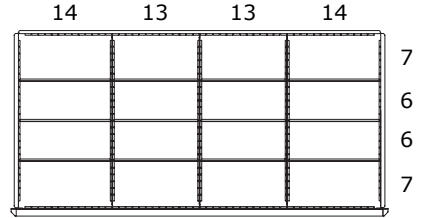

16 Compartments

Catalog No.	Size	Wt. Each	Price
D1-4824030-1306	3"	34.49	\$387.30
D1-4824045-1306	4-1/2"	36.62	\$404.09
D1-4824060-1306	6"	41.64	\$419.33
D1-4824075-1306	7-1/2"	42.31	\$431.85
D1-4824090-1306	9"	45.79	\$436.80
D1-4824105-1306	10-1/2"	50.88	\$477.43
D1-4824120-1306	12"	50.88	\$480.88

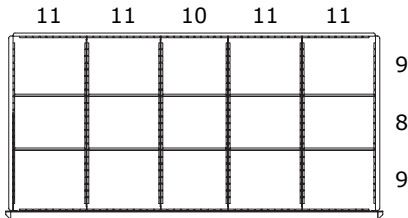

15 Compartments

Catalog No.	Size	Wt. Each	Price
D1-4824030-1108	3"	34.43	\$397.29
D1-4824045-1108	4-1/2"	36.83	\$415.27
D1-4824060-1108	6"	42.47	\$429.35
D1-4824075-1108	7-1/2"	43.14	\$437.34
D1-4824090-1108	9"	47.08	\$446.82
D1-4824105-1108	10-1/2"	52.77	\$481.93
D1-4824120-1108	12"	52.77	\$485.38

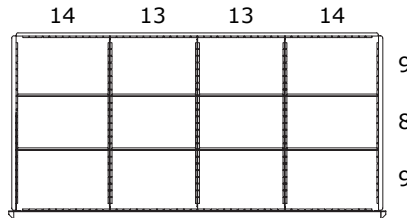

12 Compartments

Catalog No.	Size	Wt. Each	Price
D1-4824030-1308	3"	33.61	\$384.36
D1-4824045-1308	4-1/2"	35.74	\$400.47
D1-4824060-1308	6"	40.76	\$414.57
D1-4824075-1308	7-1/2"	41.43	\$426.78
D1-4824090-1308	9"	44.91	\$432.04
D1-4824105-1308	10-1/2"	50.00	\$468.70
D1-4824120-1308	12"	50.00	\$472.27

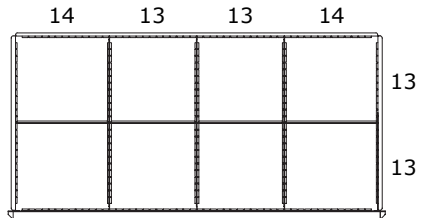

8 Compartments

Catalog No.	Size	Wt. Each	Price
D1-4824030-1313	3"	32.73	\$381.43
D1-4824045-1313	4-1/2"	34.86	\$396.86
D1-4824060-1313	6"	39.88	\$409.79
D1-4824075-1313	7-1/2"	40.55	\$420.56
D1-4824090-1313	9"	44.03	\$427.27
D1-4824105-1313	10-1/2"	49.12	\$458.38
D1-4824120-1313	12"	49.12	\$462.07

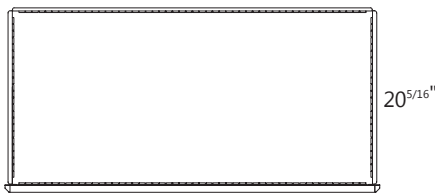

1 Compartment

Catalog No.	Size	Wt. Each	Price
D1-4824030-0000	3"	29.39	\$341.47
D1-4824045-0000	4-1/2"	30.71	\$350.55
D1-4824060-0000	6"	33.87	\$362.41
D1-4824075-0000	7-1/2"	34.54	\$363.66
D1-4824090-0000	9"	36.64	\$379.87
D1-4824105-0000	10-1/2"	39.93	\$386.82
D1-4824120-0000	12"	39.93	\$390.03

- Part numbers include: drawer(s), slides, partitions and dividers (partitions & dividers - factory installed).

DRAWER DIVIDERS (SIDE TO SIDE)

Divides the drawer along its width, adjustable every 20mm (0.799") center to center. Fabricated in galvanized steel (G60 finish) and requires two (2) self-tapping screws for attachment (part# MDC-0705).



Drawer Height

Compartment Size Clear (nominal)	Part # for 4S Drawers (1-15/16"H)	Price	Part # for 5S, 6S, 7S Drawers (2-15/16"H)	Price	Part # for 8S, 9S Drawers (4-15/16"H)	Price
1-7/8" (3S)	M1-02H-03D	\$1.75	M1-03H-03D	\$1.79	M1-05H-03D	\$1.82
2-11/16" (4S)	M1-02H-04D	\$1.79	M1-03H-04D	\$1.81	M1-05H-04D	\$1.84
3-1/2" (5S)	M1-02H-05D	\$1.83	M1-03H-05D	\$1.86	M1-05H-05D	\$1.93
4-1/4" (6S)	M1-02H-06D	\$1.86	M1-03H-06D	\$1.92	M1-05H-06D	\$2.00
5-1/16" (7S)	M1-02H-07D	\$1.89	M1-03H-07D	\$1.91	M1-05H-07D	\$2.09
5-7/8" (8S)	M1-02H-08D	\$1.91	M1-03H-08D	\$1.93	M1-05H-08D	\$2.16
6-11/16" (9S)	M1-02H-09D	\$1.94	M1-03H-09D	\$1.97	M1-05H-09D	\$2.23
7-1/2" (10S)	M1-02H-10D	\$1.97	M1-03H-10D	\$2.07	M1-05H-10D	\$2.31
8-1/4" (11S)	M1-02H-11D	\$2.01	M1-03H-11D	\$2.10	M1-05H-11D	\$2.41
9-1/16" (12S)	M1-02H-12D	\$2.03	M1-03H-12D	\$2.12	M1-05H-12D	\$2.49
9-7/8" (13S)	M1-02H-13D	\$2.05	M1-03H-13D	\$2.18	M1-05H-13D	\$2.57
10-11/16" (14S)	M1-02H-14D	\$2.07	M1-03H-14D	\$2.22	M1-05H-14D	\$2.63
12-1/4" (16S)	M1-02H-16D	\$4.99	M1-03H-16D	\$5.21	M1-05H-16D	\$5.67
13-1/8" (17S)	M1-02H-17D	\$5.19	M1-03H-17D	\$5.43	M1-05H-17D	\$5.93
13-7/8" (18S)	M1-02H-18D	\$5.41	M1-03H-18D	\$5.68	M1-05H-18D	\$6.17
17-7/8" (23S)	M1-02H-23D	\$6.44	M1-03H-23D	\$6.78	M1-05H-23D	\$7.43
18-5/8" (24S)	M1-02H-24D	\$7.38	M1-03H-24D	\$7.71	M1-05H-24D	\$7.77

Compartment Size Clear (nominal)	Part # for 10S, 11S, 12S Drawers (6-11/16"H)	Price	Part # for 13S, 14S, 15S Drawers (8-15/16"H)	Price	Part # for 16S, 17S, 18S Drawers (11-7/16"H)	Price
1-7/8" (3S)	M1-07H-03D	\$1.91	M1-09H-03D	\$2.03	M1-12H-03D	\$2.19
2-11/16" (4S)	M1-07H-04D	\$1.95	M1-09H-04D	\$2.09	M1-12H-04D	\$2.24
3-1/2" (5S)	M1-07H-05D	\$2.06	M1-09H-05D	\$2.21	M1-12H-05D	\$2.44
4-1/4" (6S)	M1-07H-06D	\$2.16	M1-09H-06D	\$2.38	M1-12H-06D	\$2.58
5-1/16" (7S)	M1-07H-07D	\$2.23	M1-09H-07D	\$2.49	M1-12H-07D	\$2.79
5-7/8" (8S)	M1-07H-08D	\$2.35	M1-09H-08D	\$2.63	M1-12H-08D	\$2.91
6-11/16" (9S)	M1-07H-09D	\$2.50	M1-09H-09D	\$2.76	M1-12H-09D	\$3.08
7-1/2" (10S)	M1-07H-10D	\$2.60	M1-09H-10D	\$2.93	M1-12H-10D	\$3.29
8-1/4" (11S)	M1-07H-11D	\$2.68	M1-09H-11D	\$3.11	M1-12H-11D	\$3.56
9-1/16" (12S)	M1-07H-12D	\$2.77	M1-09H-12D	\$3.23	M1-12H-12D	\$3.57
9-7/8" (13S)	M1-07H-13D	\$2.94	M1-09H-13D	\$3.31	M1-12H-13D	\$3.95
10-11/16" (14S)	M1-07H-14D	\$3.01	M1-09H-14D	\$3.49	M1-12H-14D	\$3.96
12-1/4" (16S)	M1-07H-16D	\$6.07	M1-09H-16D	\$6.55	M1-12H-16D	\$7.54
13-1/8" (17S)	M1-07H-17D	\$6.33	M1-09H-17D	\$6.93	M1-12H-17D	\$7.80
13-7/8" (18S)	M1-07H-18D	\$6.78	M1-09H-18D	\$7.16	M1-12H-18D	\$7.97
17-7/8" (23S)	M1-07H-23D	\$8.11	M1-09H-23D	\$8.81	M1-12H-23D	\$9.86
18-5/8" (24S)	M1-07H-24D	\$8.44	M1-09H-24D	\$9.03	M1-12H-24D	\$10.15

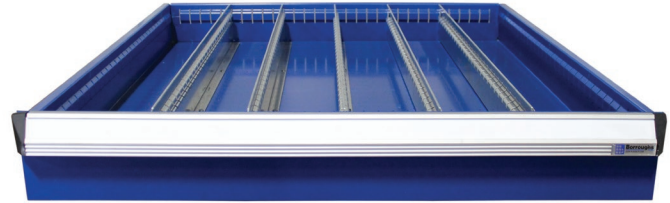

DRAWER PARTITIONS (FRONT TO BACK)

Divides the drawer along its depth, adjustable every 20mm (0.799") center to center. Fabricated in galvanized steel (G60 finish) and two (2) self-tapping screws for attachment (screw part# MDC-0705).

Drawer Height										
Drawer Depth Clear (nominal)	Part Number for 3" Drawers (1-15/16"H)	Price	Part Number for 4 1/2" Drawers (2-15/16"H)	Price	Part Number for 6" & 7 1/2" Drawers (4-15/16"H)	Price	Part Number for 9" Drawers (6-11/16"H)	Price	Part Number for 10 1/2" & 12" Drawers (8-15/16"H)	Price
13-15/16" (18D)	M1-02H-18P	\$13.12	M1-03H-18P	\$13.28	M1-05H-18P	\$13.63	M1-07H-18P	\$14.03	M1-09H-18P	\$15.77
20-5/16" (24D)	M1-02H-26P	\$13.85	M1-03H-26P	\$14.02	M1-05H-26P	\$14.87	M1-07H-26P	\$15.27	M1-09H-26P	\$16.99



DRAWER PARTITIONS (SIDE TO SIDE)

Divides the drawer along its width, adjustable every 20mm (0.799") center to center. Fabricated in galvanized steel (G60 finish) and requires two (2) self-tapping screws for attachment (part# MDC-0705).

Drawer Height						
Drawer Width Clear (nominal)	Part # for 4S Drawers (1-15/16"H)	Price	Part # for 5S, 6S, 7S Drawers (2-15/16"H)	Price	Part # for 8S, 9S Drawers (4-15/16"H)	Price
17-7/8" (23W)	M1-02H-23P	\$7.06	M1-03H-23P	\$7.56	M1-05H-23P	\$10.13
25-1/8" (30W)	M1-02H-32P	\$7.89	M1-03H-32P	\$8.68	M1-05H-32P	\$12.14
40-1/4" (45W)	M1-02H-51P	\$10.58	M1-03H-51P	\$11.63	M1-05H-51P	\$18.39
55-3/8" (60W)	M1-02H-70P	\$12.89	M1-03H-70P	\$14.50	M1-05H-70P	\$21.13

Drawer Height						
Drawer Width Clear (nominal)	Part # for 10S, 11S, 12S Drawers (6-11/16"H)	Price	Part # for 13S, 14S, 15S Drawers (8-15/16"H)	Price	Part # for 16S, 17S, 18S Drawers (11-7/16"H)	Price
17-7/8" (23W)	M1-07H-23P	\$11.00	M1-09H-23P	\$12.46	M1-12H-23P	\$14.13
25-1/8" (30W)	M1-07H-32P	\$13.48	M1-09H-30P	#N/A	M1-12H-32P	\$17.39
40-1/4" (45W)	M1-07H-51P	\$18.59	M1-09H-51P	\$21.79	M1-12H-51P	\$24.91
55-3/8" (60W)	M1-07H-70P	\$23.48	M1-09H-70P	\$27.66	M1-12H-70P	\$31.59



ROLL-OUT SHELVES

- Easy access to large, bulky items.
- Supports even loads of 400 lbs.
- Drawer front is notched to allow flush access to top of reinforcing channels.

PART#	W x D	Wt. Each	Price
D1-3618R	36" x 18"	26.12	\$269.65
D1-3624R	36" x 24"	28.38	\$326.07
D1-4818R	48" x 18"	36.44	\$304.08
D1-4824R	48" x 24"	39.60	\$346.31

DRAWER MOUNTING BRACKET PANEL

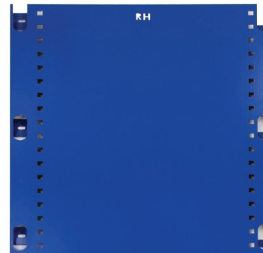

- Works with Angle or Beaded Post.
- Part numbers consist of both uprights, making a set; one left and one right - includes mounting hardware.

Please specify color.

24"D PART#	Price	18"D PART#	Price	HEIGHT
D1-0624DMU	\$58.30	D1-0618DMU	\$55.00	6" High
D1-1224DMU	\$68.20	D1-1218DMU	\$62.70	12" High
D1-1824DMU	\$81.40	D1-1818DMU	\$73.70	18" High
D1-2424DMU	\$95.70	D1-2418DMU	\$85.80	24" High
D1-3624DMU	\$138.60	D1-3618DMU	\$132.00	36" High
D1-4824DMU	\$166.10	D1-4818DMU	\$147.40	48" High

DIS/MDC LABEL HOLDERS-SNAP ON (FOR DIS & MODULAR DRAWERS)



PART#	Description	W x D	Price
MDC-0390	Snap-On Label Holder	2 3/4" x 7/8"	\$1.00
MDC-0391	Blank Labels (36 labels per sheet)	8 1/2" x 11" sheet	\$1.80/per sheet
M1-DDLK	Drawer Divider Label Kit	180 holders, 5 label	\$64.28

DIS/MDC PLASTIC BINS (FOR DIS & MODULAR DRAWERS)



PART#	W x D	Wt. Each	Price
M1-232BN	2" x 3" x 2"	0.05	\$3.24
M1-242BN	2" x 4" x 2"	0.06	\$4.20
M1-262BN	2" x 6" x 2"	0.09	\$5.76
M1-332BN	3" x 3" x 2"	0.06	\$3.36
M1-342BN	3" x 4" x 2"	0.08	\$3.92
M1-362BN	3" x 6" x 2"	0.10	\$4.88
M1-662BN	6" x 6" x 2"	0.20	\$9.72
M1-233BN	2" x 3" x 3"	0.07	\$4.32
M1-243BN	2" x 4" x 3"	0.08	\$5.76
M1-263BN	2" x 6" x 3"	0.14	\$8.64
M1-333BN	3" x 3" x 3"	0.08	\$5.84
M1-343BN	3" x 4" x 3"	0.09	\$7.80
M1-363BN	3" x 6" x 3"	0.16	\$9.72
M1-663BN	6" x 6" x 3"	0.26	\$18.16

- See interior layouts on page 30.

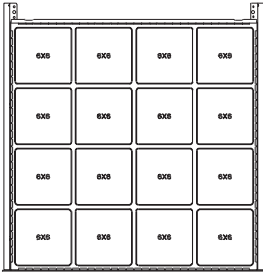

30"W x 29"D - 16 BINS

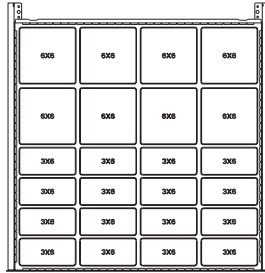

30"W x 29"D - 24 BINS

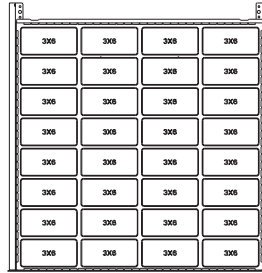

30W - 32 BINS

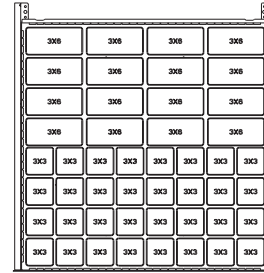

30"W x 29"D - 48 BINS

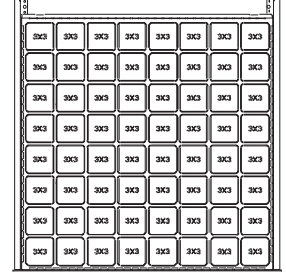

30"W x 29"D - 64 BINS

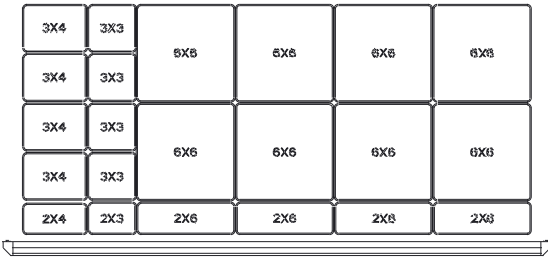

36"W x 18"D - 22 BINS

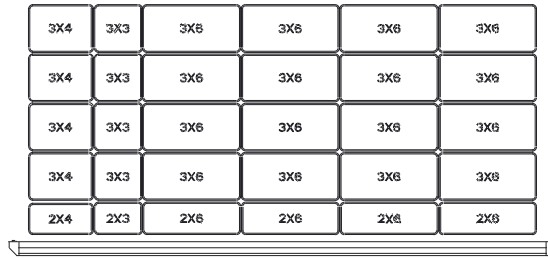

36"W x 18"D - 30 BINS

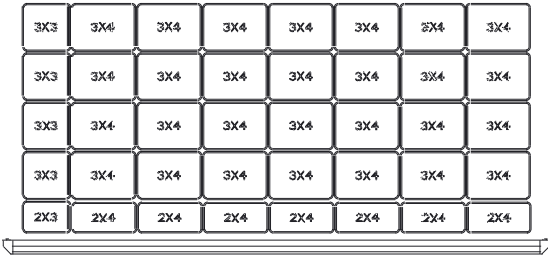

36"W x 18"D - 40 BINS

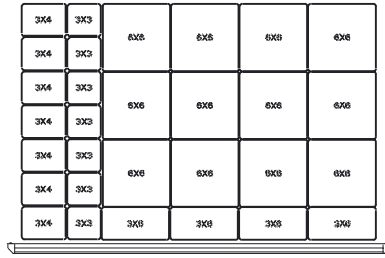

36"W x 24"D - 30 BINS

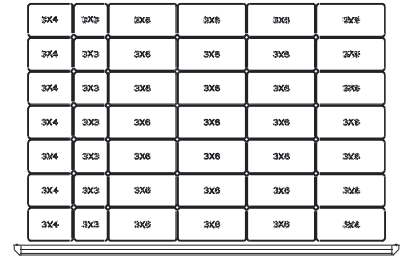

36"W x 24"D - 42 BINS

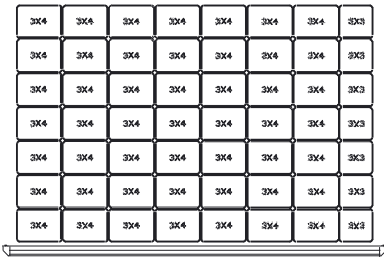

36"W x 24"D - 56 BINS

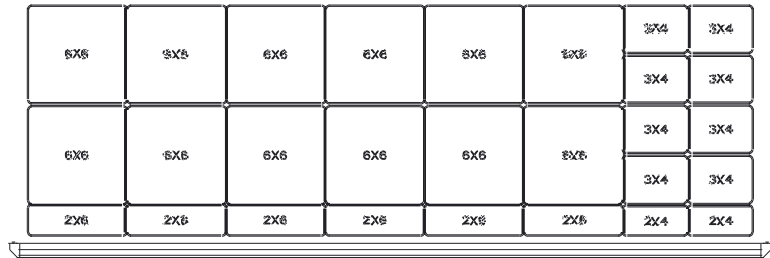

48"W x 18"D - 28 BINS

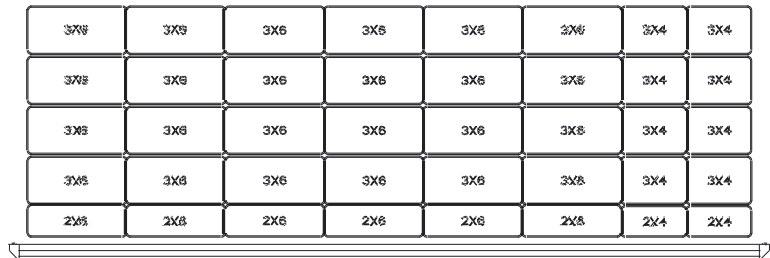

48"W x 18"D - 40 BINS

3X4	3X4	3X4	3X4	3X4	3X4	3X4	3X4	3X4	3X4	3X4
3X4	3X4	3X4	3X4	3X4	3X4	3X4	3X4	3X4	3X4	3X4
3X4	3X4	3X4	3X4	3X4	3X4	3X4	3X4	3X4	3X4	3X4
3X4	3X4	3X4	3X4	3X4	3X4	3X4	3X4	3X4	3X4	3X4
2X4	2X4	2X4	2X4	2X4	2X4	2X4	2X4	2X4	2X4	2X4

48"W x 18"D - 55 BINS

3X6	3X6	3X6	3X6	3X6	3X6	3X4	3X4
3X6	3X6	3X6	3X6	3X6	3X6	3X4	3X4
3X6	3X6	3X6	3X6	3X6	3X6	3X4	3X4
3X6	3X6	3X6	3X6	3X6	3X6	3X4	3X4
3X6	3X6	3X6	3X6	3X6	3X6	3X4	3X4
3X6	3X6	3X6	3X6	3X6	3X6	3X4	3X4
3X6	3X6	3X6	3X6	3X6	3X6	3X4	3X4

48"W x 24"D - 56 BINS

3X4	3X4	3X4	3X4	3X4	3X4	3X4	3X4	3X4	3X4	3X4
3X4	3X4	3X4	3X4	3X4	3X4	3X4	3X4	3X4	3X4	3X4
3X4	3X4	3X4	3X4	3X4	3X4	3X4	3X4	3X4	3X4	3X4
3X4	3X4	3X4	3X4	3X4	3X4	3X4	3X4	3X4	3X4	3X4
3X4	3X4	3X4	3X4	3X4	3X4	3X4	3X4	3X4	3X4	3X4
3X4	3X4	3X4	3X4	3X4	3X4	3X4	3X4	3X4	3X4	3X4
3X4	3X4	3X4	3X4	3X4	3X4	3X4	3X4	3X4	3X4	3X4

48"W x 24"D - 77 BINS

3X6	3X6	3X6	3X6	3X6	3X6	3X4	3X4
6X6	6X6	6X6	6X6	6X6	6X6	3X4	3X4
6X6	6X6	6X6	6X6	6X6	6X6	3X4	3X4
6X6	6X6	6X6	6X6	6X6	6X6	3X4	3X4
6X6	6X6	6X6	6X6	6X6	6X6	3X4	3X4



48"W x 24"D - 38 BINS



Bulk Storage Units

7'0"/84" High

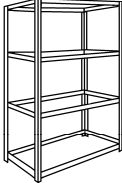
Extra Beam Levels

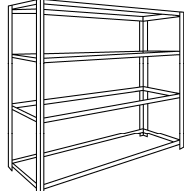
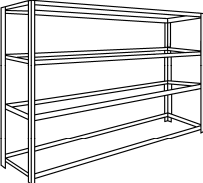
	Starter Unit Catalog No.	List Price	Adder Unit Catalog No.	List Price	Unit Depth	Beam Type	Wt.	Catalog No.	List Price
48" WIDE 4 Beam Levels 	B4818DR47	\$187.41	A4818DR47	\$182.86	18"	Angle	59.2	BL4818DR	\$31.05
	B4824DR47	\$196.76	A4824DR47	\$192.38	24"	Angle	62.4	BL4824DR	\$36.34
	B4830DR47	\$205.97	A4830DR47	\$198.10	30"	Angle	65.6	BL4830DR	\$36.80
	B4836DR47	\$212.42	A4836DR47	\$205.71	36"	Angle	68.8	BL4836DR	\$37.25
	B4848DR47	\$230.00	A4848DR47	\$217.14	48"	Angle	76	BL4848DR	\$41.64
60" WIDE 4 Beam Levels 	B6018DR47	\$209.73	A6018DR47	\$203.81	18"	Angle	65.6	BL6018DR	\$36.58
	B6018DH47	\$238.14	A6018DH47	\$228.57		Angle	72.4	BL6018DH	\$43.68
	B6018CH47	\$268.12	A6018CH47	\$274.29		Channel	98	BL6018CH	\$53.67
	B6024DR47	\$219.08	A6024DR47	\$213.33	24"	Angle	68.8	BL6024DR	\$38.91
	B6024DH47	\$251.71	A6024DH47	\$241.90		Angle	77.6	BL6024DH	\$47.07
	B6024CH47	\$281.68	A6024CH47	\$266.60		Channel	103.2	BL6024CH	\$57.06
	B6030DR47	\$228.28	A6030DR47	\$220.95	30"	Angle	72	BL6030DR	\$41.21
	B6030DH47	\$267.15	A6030DH47	\$252.06		Angle	82.8	BL6030DH	\$50.93
	B6030CH47	\$297.12	A6030CH47	\$282.03		Channel	108.4	BL6030CH	\$60.92
	B6036DR47	\$234.73	A6036DR47	\$225.71	36"	Angle	75.2	BL6036DR	\$42.83
	B6036DH47	\$279.28	A6036DH47	\$264.20		Angle	88	BL6036DH	\$53.96
	B6036CH47	\$309.26	A6036CH47	\$294.17		Channel	113.6	BL6036CH	\$63.96
72" WIDE 4 Beam Levels 	B7218DR47	\$234.17	A7218DR47	\$226.67	18"	Angle	72.8	BL7218DR	\$42.69
	B7218DH47	\$262.59	A7218DH47	\$247.62		Angle	79.6	BL7218DH	\$49.79
	B7218CH47	\$309.43	A7218CH47	\$294.34		Channel	109.2	BL7218CH	\$65.40
	B7224DR47	\$243.52	A7224DR47	\$238.10	24"	Angle	76	BL7224DR	\$45.02
	B7224DH47	\$276.15	A7224DH47	\$261.07		Angle	84.8	BL7224DH	\$53.18
	B7224CH47	\$323.00	A7224CH47	\$307.91		Channel	114.4	BL7224CH	\$68.80
	B7230DR47	\$252.72	A7230DR47	\$243.81	30"	Angle	79.2	BL7230DR	\$47.32
	B7230DH47	\$291.59	A7230DH47	\$276.50		Angle	90	BL7230DH	\$57.04
	B7230CH47	\$338.43	A7230CH47	\$323.34		Channel	119.6	BL7230CH	\$72.66
	B7236DR47	\$259.18	A7236DR47	\$251.43	36"	Angle	82.4	BL7236DR	\$48.94
	B7236DH47	\$303.73	A7236DH47	\$288.64		Angle	95.2	BL7236DH	\$60.08
	B7236CH47	\$350.57	A7236CH47	\$335.48		Channel	117.4	BL7236CH	\$75.69
96" WIDE 4 Beam Levels 	B7248DR47	\$276.76	A7248DR47	\$320.35	48"	Angle	89.6	BL7248DR	\$53.33
	B7248DH47	\$328.82	A7248DH47	\$313.74		Angle	106.4	BL7248DH	\$66.35
	B7248CH47	\$375.66	A7248CH47	\$360.58		Channel	128.8	BL7248CH	\$81.96
	B9618DR47	\$323.76	A9618DR47	\$308.67	18"	Angle	100	BL9618DR	\$65.08
	B9618CH47	\$369.41	A9618CH47	\$354.32		Channel	130	BL9618CH	\$80.30
	B9624DR47	\$341.54	A9624DR47	\$333.33	24"	Angle	107.7	BL9624DR	\$69.53
	B9624CH47	\$387.19	A9624CH47	\$372.11		Channel	137.2	BL9624CH	\$84.75
	B9630DR47	\$363.21	A9630DR47	\$348.13	30"	Angle	114.4	BL9630DR	\$74.95
	B9630CH47	\$408.86	A9630CH47	\$393.78		Channel	144.4	BL9630CH	\$90.16
	B9636DR47	\$381.03	A9636DR47	\$365.95	36"	Angle	121.6	BL9636DR	\$79.40
	B9636CH47	\$426.68	A9636CH47	\$411.60		Channel	151.6	BL9636CH	\$94.62
	B9648DR47	\$413.65	A9648DR47	\$398.56	48"	Angle	136.8	BL9648DR	\$87.55
B9648CH47	\$459.30	A9648CH47	\$444.21		Channel	166.8	BL9648CH	\$102.77	

All units include metal framing only. Decking material must be ordered separately (See Page 34).

*Includes (1) support tie per level except 96" which has (2) support ties.

**Units with channel beams have angle beams with support ties located directly at the floor level.

***Capacities are for steel beams only with evenly distributed loads and do not reflect the capacity of the decking material.

All units shipped K.D.

PART NUMBERING SYSTEMS

PRECONFIGURED CATALOG UNITS

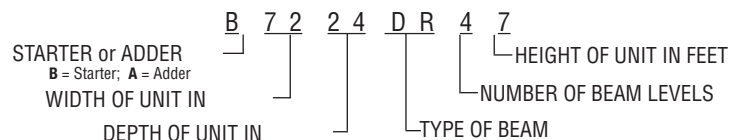



SR = Single Rivet Beams
 LP = Double Rivet Low Profile Beams

ZB = Double Rivet Z Beams
 DH = Double Rivet Angle Beams with Support Tie
 CH = Double Rivet Channel Beams with Support Tie

Single Rivet Shelf Units*

7'0"/84" High



Extra Shelf Levels**

		Starter Unit Catalog No.	List Price	Adder Unit Catalog No.	List Price	Unit Depth	Wt.	Catalog No.	List Price
36" WIDE 6 Beam Levels		B3612SR67	\$182.86	A3612SR67	\$186.67	12"	48.2	BL3612SR	\$15.62
		B3618SR67	\$186.67	A3618SR67	\$190.48	18"	50.2	BL3618SR	\$15.81
		B3624SR67	\$192.38	A3624SR67	\$194.29	24"	52.4	BL3624SR	\$16.19
		B3636SR67	\$247.62	A3636SR67	\$247.62	36"	65.8	BL3636SR	\$30.86
42" WIDE 6 Beam Levels		B4212SR67	\$198.10	A4212SR67	\$198.10	12"	51.4	BL4212SR	\$16.76
		B4218SR67	\$201.90	A4218SR67	\$201.90	18"	53.4	BL4218SR	\$17.30
		B4224SR67	\$205.71	A4224SR67	\$209.52	24"	55.6	BL4224SR	\$17.71
		B4236SR67	\$259.05	A4236SR67	\$262.86	36"	68.8	BL4236SR	\$32.95
48" WIDE 6 Beam Levels		B4812SR67	\$201.90	A4812SR67	\$216.19	12"	55.8	BL4812SR	\$18.10
		B4818SR67	\$205.71	A4818SR67	\$218.10	18"	57.8	BL4818SR	\$18.29
		B4824SR67	\$211.43	A4824SR67	\$225.75	24"	60	BL4824SR	\$19.35
		B4836SR67	\$266.67	A4836SR67	\$266.67	36"	73.2	BL4836SR	\$33.52

Double Rivet Low Profile Shelf Units*

7'0"/84" High

Extra Shelf Levels**

		Starter Unit Catalog No.	List Price	Adder Unit Catalog No.	List Price	Unit Depth	Wt.	Catalog No.	List Price
36" WIDE 7 Beam Levels		B3612LP77	\$234.29	A3612LP77	\$243.81	12"	54.2	BL3612LP	\$21.92
		B3618LP77	\$243.50	A3618LP77	\$245.71	18"	56.2	BL3618LP	\$23.43
		B3624LP77	\$248.95	A3624LP77	\$251.43	24"	58.4	BL3624LP	\$24.00
		B3636LP77	\$319.05	A3636LP77	\$321.90	36"	74.6	BL3636LP	\$39.05
42" WIDE 7 Beam Levels		B4212LP77	\$239.05	A4212LP77	\$249.52	12"	57.8	BL4212LP	\$26.10
		B4218LP77	\$247.66	A4218LP77	\$252.40	18"	59.8	BL4218LP	\$27.26
		B4224LP77	\$254.29	A4224LP77	\$257.14	24"	63	BL4224LP	\$29.14
		B4236LP77	\$324.76	A4236LP77	\$326.67	36"	78.2	BL4236LP	\$42.88
48" WIDE 7 Beam Levels		B4812LP77	\$243.81	A4812LP77	\$256.19	12"	64.8	BL4812LP	\$28.76
		B4818LP77	\$253.33	A4818LP77	\$258.10	18"	66.8	BL4818LP	\$30.29
		B4824LP77	\$259.24	A4824LP77	\$261.90	24"	69	BL4824LP	\$34.67
		B4836LP77	\$335.43	A4836LP77	\$330.48	36"	85.2	BL4836LP	\$45.90

**Extra shelf levels 24" deep or less include left-to-right beams only. Extra shelf levels 30" or deeper also include front-to-back single rivet beams.

All units include metal framing only.
Decking material must be ordered seperately.

* All units include double rivet angle beams, left-to-right and front-to-back, at the top and bottom beam levels.

*** Capacities are for steel beams only with evenly distributed loads and do not reflect the capacity of the decking material.

Shelf units 24" deep or less include only (2) intermediate front-to-back single rivet beams. Units 30" or deeper include front-to-back single rivet beams at every intermediate beam level.

All units shipped K.D.

Important:

Wall, floor or top tie anchoring is recommended for units when the height to depth ratio exceeds 4.

Example: A 7'/84" high x 18" deep unit has a height to depth ratio of 4.67 and should be attached to a firm restraint, such as a floor, wall or tied overhead across the aisle to an opposite upright assembly.

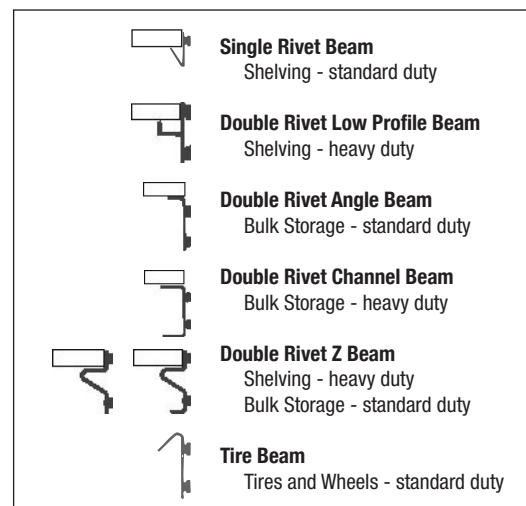

Beam Profiles



Catalog No.	Size	Wt. Each	Qty. Per Pack	List Price
Angle Post				
10061-007	5'0"/60"	3.8	8	\$10.63
10061-000	6'0"/72"	4.1	8	\$14.03
10061-001	7'0"/84"	4.8	8	\$15.86
10061-002	8'0"/96"	5.5	8	\$17.72
10061-003	9'0"/108"	6.2	8	\$23.85
10061-004	10'0"/120"	6.9	8	\$25.60
10061-005	11'0"/132"	8.4	8	\$28.38
10061-006	12'0"/144"	8.3	8	\$29.94
Heavy Duty Angle Post				
10060-000	6'0"/72"	4.7	8	\$14.86
10060-001	7'0"/84"	5.4	8	\$16.94
10060-002	8'0"/96"	6.2	8	\$18.97
10060-003	9'0"/108"	7	8	\$26.29
10060-004	10'0"/120"	7.8	8	\$28.46
10060-005	11'0"/132"	10.2	8	\$31.39
10060-006	12'0"/144"	9.3	8	\$32.80
10060-007	13'0"/156"	12.1	8	\$35.92
10060-008	14'0"/168"	10.9	8	\$38.10
10060-009	15'0"/180"	11.6	8	\$40.76
10060-010	16'0"/192"	12.4	8	\$42.48
Tie Plate – Angle Post				
10066-000	-	0.2	50	\$4.57
Post Splicer – Angle Post				
10065-000	-	0.4	50	\$11.18
T Post				
10132-000	72"	8.3	4	\$27.81
10132-001	84"	9.6	4	\$30.10
10132-002	96"	11	4	\$33.14
10132-003	108"	12.4	4	\$46.48
10132-004	120"	13.8	4	\$49.90
10132-005	132"	17	4	\$54.86
10132-006	144"	16.5	4	\$57.90
Post Splicer - T Post				
10145-000	-	1.2	112	\$12.31
Foot Plate				
10103-000	A/T	0.3	50	\$5.79
Single Rivet Beam				
10063-000	12"	0.5	20	\$5.57
10063-001	15"	0.6	20	\$5.68
10063-002	18"	0.7	20	\$5.89
10063-003	24"	1	20	\$6.25
10063-004	30"	1.2	20	\$7.00
10063-005	36"	1.5	20	\$7.61
10063-006	42"	1.7	20	\$8.32
10063-007	48"	2	20	\$9.07
Double Rivet Low Profile Beam				
16330-091	36"	1.8	14	\$12.00
16331-001	42"	2.1	14	\$12.76
16331-011	48"	2.5	14	\$13.52

Catalog No.	Size	Wt. Each	Qty. Per Pack	List Price
Double Rivet Z Beam				
10142-000	12"	0.9	20	\$6.25
10142-001	15"	1	20	\$6.54
10142-002	18"	1.3	20	\$6.86
10142-003	24"	1.5	20	\$8.68
10142-004	30"	2.1	20	\$9.25
10142-012	32"	2.1	20	\$9.36
10142-005	36"	2.5	20	\$9.86
10142-006	42"	2.9	20	\$10.79
10142-007	48"	3.5	10	\$11.64
10142-008	60"	4.2	10	\$15.11
10144-009	69"	4.9	10	\$17.71
10144-010	72"	5.1	10	\$18.50
Z Tie				
10110-003	24"	3	10	\$15.24
10110-004	30"	4.2	10	\$17.52
10110-012	32"	4.5	10	\$18.05
10110-005	36"	5.1	10	\$21.33
10110-006	42"	6	10	\$22.86
10110-007	48"	6.9	10	\$23.85
Double Rivet Angle Beam				
10068-000	12"	0.9	20	\$5.03
10068-001	15"	1	20	\$5.33
10068-002	18"	1.3	20	\$5.52
10068-003	24"	1.7	20	\$6.86
10068-004	30"	2.1	25	\$7.58
10068-012	32"	2.2	20	\$7.92
10068-005	36"	2.5	20	\$8.53
10068-006	42"	2.9	20	\$10.51
10068-007	48"	3.4	10	\$10.51
10068-008	60"	4.5	10	\$12.80
10068-009	69"	4.9	10	\$14.86
*10097-009	69"	4.9	10	\$38.48
10068-010	72"	5.1	10	\$16.00
10068-013	84"	6	10	\$17.22
10068-011	96"	6.8	10	\$21.03
Double Rivet Channel Beam				
10070-007	48"	4.8	8	\$14.67
10070-008	60"	6	8	\$18.20
10070-009	69"	6.9	8	\$23.70
*10098-009	69"	6.9	8	\$38.48
10070-010	72"	7.2	8	\$24.06
10070-013	84"	8.4	8	\$25.12
10070-011	96"	9.6	8	\$27.96
Support Tie				
10072-000	12"	1	20	\$6.00
10072-001	15"	1.3	20	\$6.69
10072-002	18"	1.5	20	\$7.10
10072-003	24"	1.9	20	\$8.16
10072-004	30"	2.3	20	\$9.72
10072-012	32"	2.6	20	\$10.13
10072-005	36"	2.8	10	\$11.14
10072-006	42"	3.2	10	\$11.83
10072-007	48"	3.9	10	\$13.02
10072-008	60"	4.4	10	\$16.27
Tire Beam				
10077-005	36"	3.7	10	\$11.54
10077-007	48"	4.9	10	\$13.57
10077-008	60"	6.1	10	\$16.68
10077-009	72"	7.2	10	\$28.43

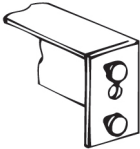
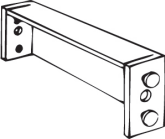
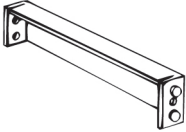
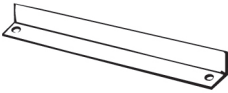
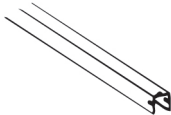
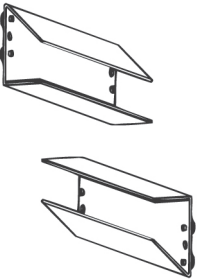
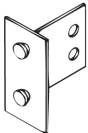
Special Height Posts are available in 3" increments. For these special heights, use the next taller size list price plus a set up charge of \$85.00 net per line item.

	Catalog No.	Size	Wt. Each	Qty. Per Pack	List Price
	Aisle Tie*				
	10073-000	30"	2.5	10	\$13.98
	10073-001	36"	2.9	10	\$16.16
	10073-002	42"	3.4	10	\$17.50
	10073-003	48"	3.9	10	\$18.92
	Back Spacer Tie				
	10079-000	18"	1.5	10	\$12.21
	Wall Tie				
	10075-000	9"	0.8	10	\$9.62
	Record Storage Support Angle				
	10099-000	15"	1	20	\$16.80
	10099-001	30"	2	10	\$17.71
	Hang Rod				
	10104-005	36"	2.3	10	\$12.69
	10104-007	48"	3.2	10	\$14.48
	10104-008	60"	4.1	10	\$18.59
	Aisle/Full Mat Decking Support				
	10111-005	36"	8.9	4	\$30.86
	10111-006	42"	10.4	4	\$31.62
	10111-007	48"	11.8	4	\$32.99
	10111-008	60"	14.7	4	\$51.81
	10111-009	69"	16.8	4	\$59.05
	10111-010	72"	17.3	4	\$58.48
	Slotted Angle Cleat				
	10113-000	Right Hand	0.3	50	\$6.82
	10113-001	Left Hand	0.3	50	\$6.82
	Rivet Span Caster Kit				
	10103-003-XXX	4" diameter	5.75	casters, brackets and hardware	\$267.89
	4" high swivel caster with brake and a 1/2"-13 threaded stem				

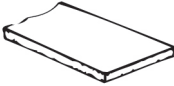
	Catalog No.	Size	Wt.	Qty.	List Price
	Particle Board Decking				
	10095-000	36" x 12"	7.8	**	\$11.97
	10095-001	36" x 15"	9.6	**	\$13.37
	10095-002	36" x 18"	11.5	**	\$17.34
	10095-003	36" x 24"	15.1	**	\$18.75
	10095-004	36" x 30"	19.3	**	\$26.32
	10095-005	42" x 12"	9	**	\$14.73
	10095-006	42" x 15"	11.2	**	\$15.90
	10095-007	42" x 18"	13.3	**	\$18.75
	10095-008	42" x 24"	17.6	**	\$22.25
	10095-009	42" x 30"	22.3	**	\$28.02
	10095-010	48" x 12"	10.3	**	\$15.19
	10095-011	48" x 15"	12.7	**	\$16.25
	10095-012	48" x 18"	15.1	**	\$18.75
	10095-013	48" x 24"	20.5	**	\$23.75
	10095-014	48" x 30"	25.4	**	\$29.30
	10095-015	48" x 36"	30.3	**	\$38.99
	10095-016	48" x 48"	40	**	\$39.50
	10095-017	60" x 18"	19.3	**	\$22.25
	10095-018	60" x 24"	25.4	**	\$25.36
	10095-019	60" x 30"	31.5	**	\$33.57
	10095-020	60" x 36"	37.6	**	\$47.64
	10095-021	60" x 48"	49.8	**	\$48.11
	10095-022	69" x 15"	18.5	**	\$26.32
	10095-023	69" x 24"	29	**	\$38.99
	10095-024	69" x 30"	36	**	\$47.64
	10095-035	69" x 48"	57.1	**	\$71.35
	10095-025	72" x 18"	22.9	**	\$33.10
	10095-026	72" x 24"	30.3	**	\$40.10
	10095-027	72" x 30"	37.7	**	\$47.98
	10095-028	72" x 36"	44.9	**	\$72.00
10095-029	72" x 48"	59.5	**	\$72.51	
10095-041	84" x 36"	52.2	**	\$73.87	
10095-030	96" x 18"	30.3	**	\$33.57	
10095-031	96" x 24"	40	**	\$39.50	
10095-032	96" x 30"	49.8	**	\$48.11	
10095-033	96" x 36"	59.5	**	\$74.21	
10095-034	96" x 48"	79	**	\$75.87	

5/8" thick
**Packed per order

Intermix Beam Families on the Same Beam Level

These beam families can be intermixed without decking problems:

- Single Rivet Beams
- Double Rivet Low Profile Beams
- Double Rivet Z Beams

These beam families can be intermixed without decking problems:

- Double Rivet Angle Beams
- Double Rivet Channel Beams

The above groupings cannot be intermixed and support decking.

Units / Posts

Overhead View

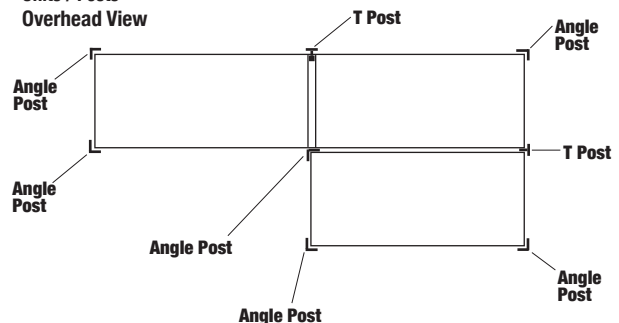

Important:

Wall, floor or top tie anchoring is recommended for units when the height to depth ratio exceeds 4.

Example: A 7/84" high x 18" deep unit has a height to depth ratio of 4.67 and should be attached to a firm restraint, such as a floor, wall or tied overhead across the aisle to an opposite upright assembly.

Specification Data

Rivet-Span® shelving units are made up of posts, side-to-side beams, and front-to-back beams. There are certain minimum requirements for beam use to ensure structural stability and safety. For example: all units must have a full "perimeter" of double rivet beams, meaning two side-to-side and two front-to-back, at both top and bottom of unit for stability. There are other requirements, see below.

Preconfigured Units - Include all required beams. Installation instructions (included with shipment) show how to position beams correctly.

Non-preconfigured Units - Follow these guidelines when specifying individual components:

- All units require a full perimeter of double rivet beams at top and bottom of unit.
- Single Rivet Beam (SRB) and Double Rivet Low Profile Beam (DRLPB) units 24" deep or less:
 - do not require SRB's front-to-back at each intermediate level in the unit.
 - 6'-8' high must have one SRB intermediate level front-to-back, located approximately in the middle of the unit.
 - 9'-10' high must have two SRB intermediate levels front-to-back, located to divide the height into 3 equal parts.
 - 11'-16' high must have three intermediate levels; a full perimeter of Double Rivet Beams (DRB) in the middle plus intermediate levels of front-to-back SRB's in the upper and lower halves of unit.
- Single Rivet Beam (SRB) and Double Rivet Low Profile Beam (DRLPB) units 30" deep or greater:
 - All units must have SRB's front-to-back at every intermediate level; units 11'-16' must have SRB's front-to-back at every intermediate level PLUS a full perimeter level of Double Rivet Beams (DRB) located approximately in the middle of the unit.

- Double Rivet Angle Beams (DRAB) and Double Rivet Channel Beams (DRCH) must have front-to-back beams at each beam level to provide decking support and ensure stability. When using DRCH from side-to-side, DRAB must be used from front-to-back.

- Tie Plates are recommended to tie adjacent Angle Post units together and to ensure structural stability. Tie plates should be used at the top and bottom of adjacent posts with additional tie plates spaced no more than 48" apart. Tie plates are not used on units with T Posts.

Basic Data

Widths

Nominal unit width = 24", 30", 32", 36", 42", 48", 60", 69", 72", 84" or 96"
 Actual single unit width = nominal width + 1/2"

Depths

Nominal unit depth = 12", 15", 18", 24", 30", 32", 36", 42" or 48"
 Actual single unit depth = nominal depth + 1/2"
 Actual back-to-back units depth = combined actual single unit depths + 7/32"

Heights

Nominal unit height = 6'/72", 7'/84", 8'/96", 10'/120", 12'/144", 14'/168", 15'/180" or 16'/192"
 Actual unit height = nominal height ± 1/32"

Length of Run

Actual length of run = sum of actual unit widths + 7/32" per adjoining unit

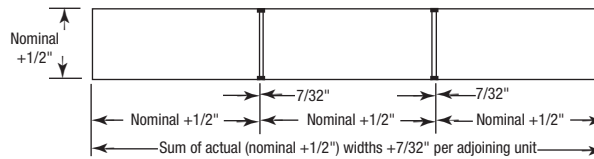

Horizontal Clear Openings

Actual clear opening between angle posts = nominal width - 2-5/8"
 Actual clear opening between heavy-duty angle posts = nominal width - 3-1/4"

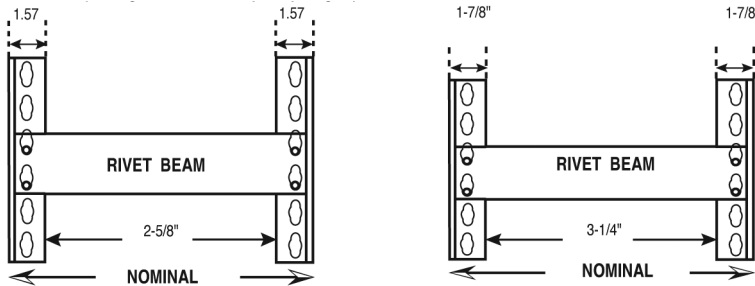

Vertical Adjustment

All beams are adjustable on 1-1/2" centers

Vertical Clear Openings

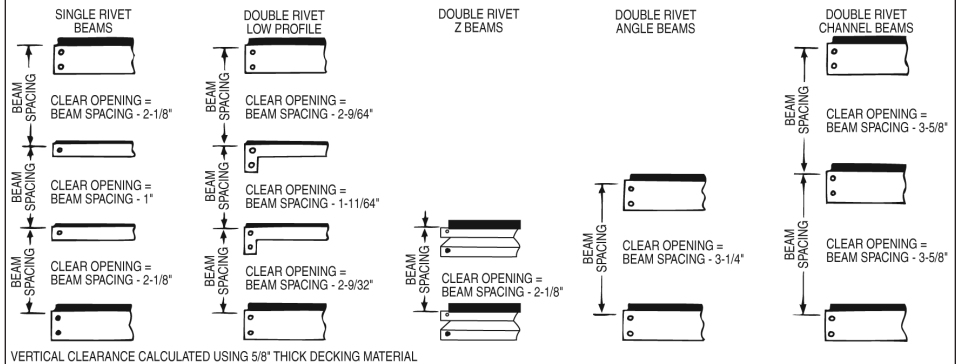

Vertical clearance calculated using 5/8" thick decking material.

Decking Material

Particle board decking, 5/8" (.625) thick, is available pre-cut from Borroughs and your local Borroughs Distributor. It can also be obtained from your local building material supplier. Other types and thicknesses of decking material, such as plywood, structure wood, oriented strand board or wire decking may be desired based upon load or use. These also can be obtained from your Borroughs Distributor.

When supplying your own decking material, cut the decking to the nominal unit size +0" - 1/8" (.125). If single rivet beams or double rivet low profile beams are being used in the left-to-right position, cut the decking material 3/16" (.188) under the nominal unit depth for easier assembly. Similarly, if either of these types of beams are being used in the front-to-back position to support the decking, also cut the decking material 3/16" (.188) under the nominal unit width.

Calculated Post Capacities

Pounds Allowable Load Per Post

Maximum Beam Spacing In Inches	Angle Post	Heavy-Duty Angle Post
48"	1,170	1,750
42"	1,315	1,960
36"	1,460	2,180
30"	1,605	2,390
24"	1,750	2,610
18"	1,896	2,830
12"	2,040	3,050

• Maximum beam spacing is determined as the distance between left-to-right beams or front-to-back beams, whichever is greater.

• Capacities are for vertical loads only where seismic forces are not a factor.

Beam Capacities

Maximum Uniformity Distributed Loads Pounds Per Beam Pair**

Beam Length	Single Rivet Beam	Double Rivet Low Profile Beam	Double Rivet Z Beam	Double Rivet Z Beam w/ Z Tie*	Double Rivet Angle Beam	Double Rivet Angle Beam w/ Support Tie*	Double Rivet Channel Beam w/ Support Tie*
36"	350	450	1,400	-	1,400	-	-
42"	260	430	1,350	-	1,000	-	-
48"	240	400	1,300	1,600	730	1,700	-
60"	-	-	800	950	680	1,300	2,250
69"	-	-	600	900	460	1,100	1,900
72"	-	-	600	900	450	1,050	1,700
96"	-	-	-	-	240	650	1,300

*One support tie except 96" which has two.

**The longest pair of beams at a given level determines the capacity for the entire level. Capacities are for steel beams only and do not reflect the capacity of the decking material.

Important:

Wall, floor or top tie anchoring is recommended for units when the height to depth ratio exceeds 4.

Example: A 7/84" high x 18" deep unit has a height to depth ratio of 4.67 and should be attached to a firm restraint, such as a floor, wall or tied overhead across the aisle to an opposite upright assembly.

BOX EDGE PLUS® Archive Records Storage

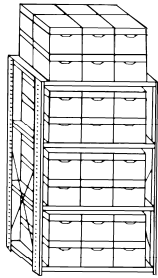

RS-423075

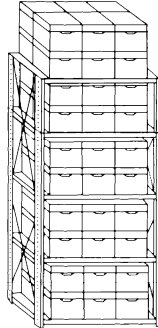

RS-423099

Records Storage Box Information:

1 cu. ft. size = 12-7/8"w x 15-5/8"d x 10-1/2"h

1.5 cu. ft. size = 12-5/8"w x 24"d x 10-1/4"h

- Record storage boxes not included.

- Units priced with beaded front posts and PLUS 2 shelves

Catalog No.	Unit Type	Unit Width	Unit Depth	Post Height	Shelf Levels	Type of Box	Number of Boxes	Wt.	List Price
RS-423075	Starter	42"	30"	6'3" / 75"	4	1 cu. ft.	48	106	\$362.19
RA-423075	Adder	42"	30"	6'3" / 75"	4	1 cu. ft.	48	93	\$320.32
RS-423275	Starter	42"	32"	6'3" / 75"	4	1 cu. ft.	48	107	\$381.44
RA-423275	Adder	42"	32"	6'3" / 75"	4	1 cu. ft.	48	94	\$339.26
Boxes stored 3 across x 2 high x 2 deep - All shelf levels utilized for storage									
RS-423099	Starter	42"	30"	99"	5	1 cu. ft.	60	138	\$481.42
RA-423099	Adder	42"	30"	99"	5	1 cu. ft.	60	119	\$407.77
RS-423299	Starter	42"	32"	99"	5	1 cu. ft.	60	139	\$505.88
RA-423299	Adder	42"	32"	99"	5	1 cu. ft.	60	120	\$431.65
Boxes stored 3 across x 2 high x 2 deep - All shelf levels utilized for storage									
RS-422475	Starter	42"	24"	6'3" / 75"	4	1.5 cu. ft.	24	102	\$317.67
RA-422475	Adder	42"	24"	6'3" / 75"	4	1.5 cu. ft.	24	90	\$276.36
Boxes stored 3 across x 2 high x 1 deep - All shelf levels utilized for storage									
RS-422499	Starter	42"	32"	99"	5	1.5 cu. ft.	30	133	\$424.89
RA-422499	Adder	42"	32"	99"	5	1.5 cu. ft.	30	115	\$352.37
Boxes stored 3 across x 2 high x 1 deep - All shelf levels utilized for storage									

Important:

Wall, floor or top tie anchoring is recommended for units when the height to depth ratio exceeds 4.

Example: A 7'3"/87" high x 18" deep unit has a height to depth ratio of 4.83. Two 8'3"/99" high x 12" deep units back-to-back have a height to depth ratio of 4.12.

These units should be attached to a firm restraint, such as a floor, wall or tied overhead across the aisle to an opposite upright assembly.

RIVET-SPAN® Archive Records Storage



B6930DH47

Starter Units Catalog No.	List Price	Adder Units Catalog No.	List Price	Unit Width	Unit Depth	Post Height	Beam Levels	Type of Box	Number of Boxes	Wt.
•B6915DR36	\$177.47	A6915DR36	\$171.43	69"	15"	72"	3	1 cu. ft.	30	53.8
•B6915DR47	\$225.23	A6915DR47	\$217.14	69"	15"	84"	4	1 cu. ft.	40	68.8
•B6915DR59	\$294.24	A6915DR59	\$287.62	69"	15"	108"	5	1 cu. ft.	50	86.6
Boxes stored 5 across x 2 high x 1 deep - All beam levels utilized for storage										
•B6930DH36	\$222.60	A6930DH36	\$209.52	69"	30"	72"	3	1 cu. ft.	60	68.5
•B6930DH47	\$285.40	A6930DH47	\$270.31	69"	30"	84"	4	1 cu. ft.	80	88.5
•B6930DH59	\$369.45	A6930DH59	\$350.48	69"	30"	108"	4	1 cu. ft.	100	111.1
Boxes stored 5 across x 2 high x 2 deep - All beam levels utilized for storage										
•B6948CH36	\$283.38	A6948CH36	\$270.81	69"	48"	72"	3	1 cu. ft.	90	102.4
•B6948CH47	\$371.92	A6948CH47	\$356.83	69"	48"	84"	4	1 cu. ft.	120	133.6
•B6948CH59	\$481.71	A6948CH59	\$456.01	69"	48"	108"	5	1 cu. ft.	150	167.6
Boxes stored 5 across x 2 high x 3 deep - All beam levels utilized for storage										

For use with decking

•B6924DR36	\$186.55	A6924DR36	\$182.86	69"	24"	72"	3	1.5 cu. ft.	30	58
•B6924DR47	\$237.33	A6924DR47	\$228.57	69"	24"	84"	4	1.5 cu. ft.	40	74.4
•B6924DR59	\$309.36	A6924DR59	\$304.76	69"	24"	108"	5	1.5 cu. ft.	50	93.6
Boxes stored 5 across x 2 high x 1 deep - All beam levels utilized for storage										
•B6948CH36	\$283.38	A6948CH36	\$270.81	69"	48"	72"	3	1.5 cu. ft.	60	102.4
•B6948CH47	\$371.92	A6948CH47	\$356.83	69"	48"	84"	4	1.5 cu. ft.	80	133.6
•B6948CH59	\$481.71	A6948CH59	\$456.01	69"	48"	108"	5	1.5 cu. ft.	100	167.6
Boxes stored 5 across x 2 high x 2 deep - All beam levels utilized for storage										

Includes Records Storage
Support Angles
No Decking Required

B6915PR36	\$809.52	A6915PR36	\$814.29	69"	15"	72"	3	1 cu. ft.	30	83.8
B6915PR47	\$1,070.48	A6915PR47	\$1,070.48	69"	15"	84"	4	1 cu. ft.	40	108.8
Boxes stored 5 across x 2 high x 1 deep - All beam levels utilized for storage										
B6930PH36	\$784.26	A6930PH36	\$837.14	69"	30"	72"	3	1 cu. ft.	60	128.5
B6930PH47	\$1,025.42	A6930PH47	\$1,103.81	69"	30"	84"	4	1 cu. ft.	80	168.6
Boxes stored 5 across x 2 high x 2 deep - All beam levels utilized for storage										

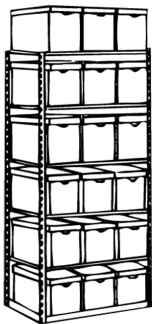

B4215SR66

For use with decking

•B4215SR66	\$194.29	A4215SR66	\$198.10	42"	15"	72"	6	1 cu. ft.	18	48.8
•B4215SR77	\$213.33	A4215SR77	\$224.76	42"	15"	84"	7	1 cu. ft.	21	55.4
•B4215SR88	\$236.19	A4215SR88	\$255.24	42"	15"	96"	8	1 cu. ft.	24	61.6
Boxes stored 3 across x 1 high x 1 deep - All beam levels utilized for storage										
•B4224SR66	\$201.90	A4224SR66	\$201.90	42"	24"	72"	6	1.5 cu. ft.	18	52.4
•B4224SR77	\$224.76	A4224SR77	\$228.57	42"	24"	84"	7	1.5 cu. ft.	21	59
•B4224SR88	\$245.71	A4224SR88	\$247.62	42"	24"	96"	8	1.5 cu. ft.	24	65.2
Boxes stored 3 across x 1 high x 1 deep - All beam levels utilized for storage										

Record Storage Box Information:

1 cu. ft. size = 12-7/8" w x 15-5/8" d x 10-1/2" h
1.5 cu. ft. size = 12-5/8" w x 24" d x 10-1/4" h

Record storage boxes not included.

All units include metal framing only. Decking material must be ordered separately.
All units shipped K.D.

Important:

Wall, floor or top tie anchoring is recommended for units when the height to depth ratio exceeds 4.

Example: A 7 7/8" high x 18" deep unit has a height to depth ratio of 4.67 and should be attached to a firm restraint, such as a floor, wall or tied overhead across the aisle to an opposite upright assembly.

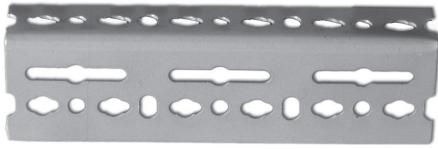
Catalog No.	Size	Wt. Per Bundle	Qty. Per Pack	List Price
				
2.38" x 1.62", 14 gauge				
SA225-10	10'	85	10/bdl.	\$392.96
SA225-12	12'	101	10/bdl.	\$470.09

Includes 75 bolts and nuts and 30 washers per bundle

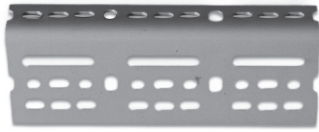
Catalog No.	Size	Wt. Per Bundle	Qty. Per Pack	List Price
				
3.12" x 1.61", 12 gauge				
SA312-10	10'	136	10/bdl.	\$511.24/bdl.
SA312-12	12'	163	10/bdl.	\$603.88 /bdl.

Includes 75 bolts and nuts and 30 washers per bundle

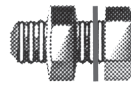



Additional Bolts, Nuts & Washers

75 Bolts ♦ 75 Nuts ♦ 30 Washers

00527-000	5/16" x 5/8"	5	Pkg.	\$26.32/pkg.
-----------	--------------	---	------	--------------





NOTE: Connection Load Limit: With a safety factor of 1.5, the load limit per bolt is 1120 lbs.
(Example: A shelf loaded with 5000 lbs. would result in load of 1250 lbs. per connection and would require two (2) bolts per connection).

Column Sections									
Unsupported Length in Feet	Type	3'	4'	5'	6'	7'	8'	9'	10'
	125	810	590	420	290	-	-	-	-
	160	1460	1170	970	770	-	-	-	-
	225	1890	1420	1130	940	700	-	-	-
	312	3490	2890	1990	1300	1060	-	-	-
	125	1780	1240	880	600	-	-	-	-
	160	3860	3510	3200	2700	-	-	-	-
	225	4770	4500	4190	2840	2350	1900	1500	1050
	312	7160	5450	5000	4550	3700	2590	2190	1740
	125	1780	1240	880	600	-	-	-	-
	160	3860	3510	3200	2700	-	-	-	-
	225	4770	4500	4190	2840	2350	1900	1500	1050
	312	7180	5450	5000	4550	3700	2590	2190	1740

Load in pounds

NOTE: Upright loadings are allowable axial loads for the unsupported heights listed. If loads are eccentric, they should be reduced.

Available in full bundles only. No split packages allowed.

Length of Beams in Feet	Type	Length of Beams in Feet							
		3'	4'	5'	6'	7'	8'	9'	10'
	125	510	290	-	-	-	-	-	-
	160	820	540	370	260	-	-	-	-
	225	1590	1120	830	640	510	410	-	-
	312	2790	1950	1350	1050	840	660	480	-
	125	1080	830	585	420	-	-	-	-
	160	1390	1080	855	690	560	430	-	-
	225	3090	2230	1690	1380	1130	910	730	580
	312	6100	4470	3400	2730	2200	1750	1300	1090
	125	1300	960	650	440	270	-	-	-
	160	1680	1260	960	730	580	480	-	-
	225	3740	2930	2300	1810	1460	1170	960	800
	312	7860	5940	4690	3885	4330	2740	2210	1870
	125	750	660	530	400	-	-	-	-
	160	970	870	780	660	570	450	-	-
	225	2170	1800	1540	1330	1160	970	860	690
	312	4190	3580	3190	2810	2490	2190	1990	1830
	125	-	-	-	-	-	-	-	-
	160	-	-	-	-	-	-	-	-
	225	6370	4680	3570	3010	2630	2340	2110	1910
	312	12750	9550	7610	6610	5800	5100	4590	4070

Load in pounds.

NOTE: Combination sections are bolted together on 6" centers. All figures refer to a pair of beams carrying evenly distributed loads. For concentrated loads, these figures should be halved. The loads shown above are those which give a safety factor of 1.5 while limiting deflection.

Preconfigured Units

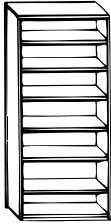
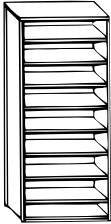
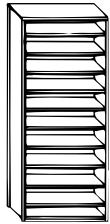
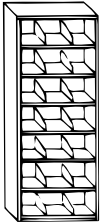
Catalog No.	Size	Wt. Per Bundle	List Price
			
FB101 6 Shelves Plus Top & Base	FB102 8 Shelves Plus Top & Base	FB103 10 Shelves Plus Top & Base	FB104 6 Shelves Plus Top & Base 14 Dividers - 6
Units			
FB101	38" x 12" x 7'/84"	104.3	\$379.07
FB102	38" x 12" x 7'/84"	114.5	\$418.73
FB103	38" x 12" x 7'/84"	124.7	\$458.36
FB104	38" x 12" x 7'/84"	118.3	\$454.95

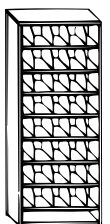
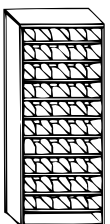
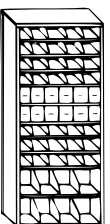
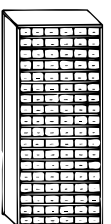
Catalog No.	Size	Wt. Per Bundle	List Price
			
FB105 8 Shelves Plus Top & Base 32 Dividers - 3'	FB106 10 Shelves Plus Top & Base 40 Dividers - 3'	FB107 10 Shelves Plus Top & Base 34 Dividers/12 Drawers	FB108 17 Shelves Plus Top & Base 108 Drawers
Units			
FB105	38" x 12" x 7'/84"	140.1	\$553.33
FB106	38" x 12" x 7'/84"	156.7	\$625.00
FB107	38" x 12" x 7'/84"	173.5	\$868.33
FB108	38" x 12" x 7'/84"	333.2	\$2,903.33

Components

Catalog No.	Size	Wt. Each	Qty. Per Pack	List Price
Bin Frames				
PBF-12-84	38" x 12" x 84"	73.7	-	\$285.00
PBF-12-96	38" x 12" x 96"	86.7	-	\$308.50
Bin Frame Components				
04445-099	Top	5.5	10	\$21.67
02718-099	Base	7.2	10	\$29.17
Backs				
04611-099	Side - 84"	17.2	10	\$70.83
09221-099	Side - 96"	21.8	10	\$76.67
Shelves				
02720-099	Bin Shelf	5.1	10	\$19.83
(label holder included)				
Sliding Shelf Dividers*				
14066-000	1-1/2" x 12"	0.8	50	\$5.03
14066-001	3" x 12"	0.8	50	\$5.52
14066-002	4-1/2" x 12"	0.9	50	\$5.90
14066-003	6" x 12"	1	50	\$6.48

Catalog No.	Size	Wt. Each	Qty. Per Pack	List Price
Drawer				
04432-099	5-3/4" x 12"	1.6	24	\$25.71
04436-099	Divider**	0.1	200	\$1.83
Label Holders				
09656-094	Full Length Label Holder		100	\$5.48
02450-099	Clip On	0.1	500	\$1.39
Long Parts Frames				
09576-099	36" x 12" Frame	5	10	\$44.41
06238-860	Spacer Rod - 12"	0.3	50	2.35
09576-098	36" x 18" Frame	5.6	10	\$47.16
06239-860	Spacer Rod - 18"	.4	50	2.83
09576-097	36" x 24" Frame	6.1	10	\$50.36
06240-860	Spacer Rod - 24"	.6	50	3.18
06242-099	Tie Angle (for use with Long Parts Frame)	1.8	10	\$30.61

*Patent Number: 3,780,876



**Available in #445 White only

Footprint: 38-1/16" x 12-1/32" (38.063" x 12.031")



All units Shipped K.D.

NOTE: All Flexi-Bin units will have #445 white backs.

FLEXI-BIN® Long Parts Bins

 LP1	 LP2	Catalog No.	Unit Width	Unit Depth	Unit Height	Vertical Storage Levels	Bulk Storage Levels	Wt.	List Price
		LP1	38"	12"	7'84"	1	2	94.2	\$433.19
		LP2	38"	12"	7'84"	2	0	99.5	\$518.02

BOX EDGE PLUS® Long Parts Bins

 LP3	 LP4	Catalog No.	Unit Width	Unit Depth	Unit Height	Vertical Storage Levels	Bulk Storage Levels	Wt.	List Price
		LP3	36"	18"	7'3"/87"	1	3	123	\$505.46
		LP4	36"	18"	7'3"/87"	2	0	117.5	\$563.61

BOX EDGE PLUS® Horizontal Molding Racks

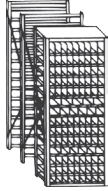
 HMR36-126	Catalog No.	Unit Width	Unit Depth	Unit Height	Openings	Opening Size	Wt.	List Price
	HMR36-126	36"	54"	7'3"/87"	126	Adjustable	474.4	\$1,947.13

BOX EDGE PLUS® Horizontal Molding Racks

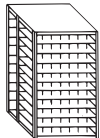
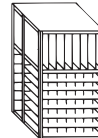
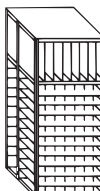
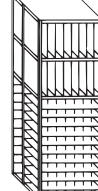
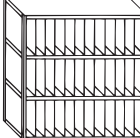
 BMR1	 BMR2	 BMR3	 BMR4	 BMR5	Catalog No.	Unit Width	Unit Depth	Unit Height	Openings	Opening Size	Wt.	List Price
					BMR1-4860	48"	60"	6'72"	77	6" x 5"	171.6	\$685.71
					BMR1+4860	48"	60"	6'72"	77	6" x 5"	365.7	\$1,333.33
					BMR2-4860	48"	60"	6'72"	57	(49) 6" x 5" (8) 5-1/2" x 24"	157.6	\$586.67
					BMR2+4860	48"	60"	6'72"	57	(49) 6" x 5" (8) 5-1/2" x 24"	283.8	\$1,131.43
					BMR3-4860	48"	60"	8'96"	85	(77) 6" x 5" (8) 5-1/2" x 24"	283.8	\$780.38
					BMR3+4860	48"	60"	8'96"	85	(77) 6" x 5" (8) 5-1/2" x 24"	443.4	\$1,544.76
					BMR4-4860	48"	60"	10'120"	93	(77) 6" x 5" (16) 5-1/2" x 24"	231.8	\$925.71
					BMR4+4860	48"	60"	10'120"	93	(77) 6" x 5" (16) 5-1/2" x 24"	499.1	\$1,759.24
					BMR5-9648	96"	48"	7'84"	48	5-1/2" x 24"	103.2	\$309.51
					BMR5+9648	96"	48"	7'84"	48	5-1/2" x 24"	431.5	\$1,414.56

(-) means basic units; no specially components; (+) are complete units.
See Note on page 44 for complete information.
All units shipped K.D.

RIVET-SPAN® Sheet Metal Racks



BSR1



BSR2



BSR3



BSR4



BSR5



BSR6

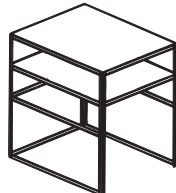

BSR7

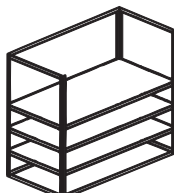

BSR8

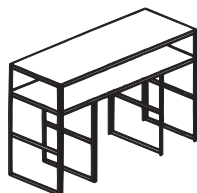

BSR9

Catalog No.	Unit Width	Unit Depth	Unit Height	Application	Wt.	List Price
BSR1-7236	72"	36"	8'/96"	Bulky Parts	85.2	\$266.65
BSR1+7236	72"	36"	8'/96"	Bulky Parts	256.3	\$554.63
BSR2-7236	72"	36"	8'/96"	Bumpers And Bars	89.6	\$359.51
BSR2+7236	72"	36"	8'/96"	Bumpers and Bars	218.1	\$575.50
BSR3-7236	72"	36"	8'/96"	Fenders And door	91.6	\$503.55
BSR3+7236	72"	36"	38'/96"	Fenders and door	220.1	\$719.53
BSR4-7236	72"	36"	8'/96"	Two Tier Fender	94.8	\$740.44
BSR4+7236	72"	36"	8'/96"	Two-Tier Fender	180.4	\$884.43
BSR5-9636	96"	36"	8'/96"	Hanging Parts	92	\$323.61
BSR5+9636	96"	36"	8'/96"	Hanging Parts	274.4	\$740.44
BSR6-4848	48"	48"	8'/96"	Hood	68.6	\$206.24
BSR6+4848	48"	48"	8'/96"	Hood	145	\$285.24
BSR7-4860	48"	60"	8'/96"	Deep Hood	86.8	\$265.00
BSR7+4860	48"	60"	8'/96"	Deep Hood	182.4	\$386.33
BSR8-7236	72"	36"	8'/96"	Top Tier Fenders	95.3	\$299.33
BSR8+7236	72"	36"	8'/96"	Top Tier Fenders	267.5	\$512.82
BSR9-9636	96"	36"	8'/96"	Quarter Panels	109.4	\$348.33
BSR9+9636	96"	36"	8'/96"	Quarter Panels	233.8	\$541.68

(-) means basic units; no specialty components; (+) are complete units.

See Note on page 44 for complete information.

All units shipped K.D.

**AUTOMOTIVE &
SHOP EQUIPMENT**



Perforated End Panel

Catalog No.	Size	Wt. Each	List Price
05157-003	18" x 75"	29	\$163.00
05157-004	18" x 87"	34	\$174.21
05157-005	18" x 99"	39	\$186.49
05158-003	24" x 75"	38	\$172.95
05158-004	24" x 87"	43	\$186.49
05158-005	24" x 99"	48	\$204.89

16 gauge steel
Available in any
standard industrial
color. Please
specify at time of
order.
Compatible with all
standard pegboard
accessories. Can
be mounted on any
Borroughs angle
post or can be wall
mounted.

RIVET-SPAN® Tire Racks		Catalog No.	Unit Width	Unit Depth	Unit Height	Beam Levels	Tire Capacity*	Wt.	List Price
 <p>Single Entry</p> <p>Double Entry</p>	B60SETB37	60"	12"	7'84"	3	15	68.8	\$240.00	
	B60SETB40	60"	12"	10'120"	4	20	91.8	\$329.52	
	B60SETB52	60"	12"	12'144"	5	25	111.6	\$388.57	
	B60DETB37	60"	42"	7'84"	3	30	136.4	\$457.14	
	B60DETB40	60"	42"	10'120"	4	40	182.4	\$640.00	
	B60DETB52	60"	42"	144"	5	50	222	\$756.19	
	*Tire Capacities reflect 5 tires per level with today's sizes of tires.								

Quicklane Counter Unit with Stainless Steel Top		Catalog No.	Unit Width	Unit Depth	Unit Height	Wt.	List Price
	HDC7224	72"	25"	39"	750	\$4,954.07	
	HDC8424	84"	25"	39"	800	\$5,096.30	
	Countertop Only						
	11150-004-000	72"	24"		40	\$851.15	
	11150-003-000	84"	24"		45	\$858.88	
	11150-005-000	96"	24"		61.5	\$975.81	
	11150-013-000	60"	24"		38.45	\$842.11	
11150-014-000	36"	24"		23.83	\$548.24		

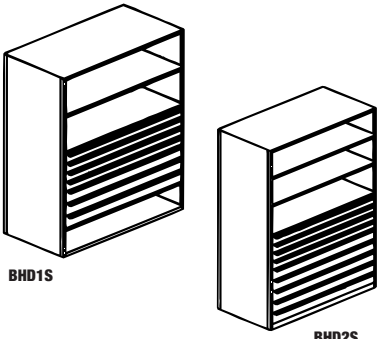
HD Drawer Bulky Bins		Catalog No.	Unit Width	Unit Depth	Unit Height	Application	Wt.	List Price	
 <p>BHD1S</p> <p>BHD2S</p>	BHD1S-3624	36"	24"	87"	Starter	494.8	\$2,991.90		
	BHD1A-3624	36"	24"	87"	Adder	482.4	\$2,941.66		
	drawers: (4) 4 1/2" - 20 compartments and (3) 6" - 16 compartments								
	BHD1S-4824	48"	24"	87"	Starter	605.5	\$3,919.81		
	BHD1A-4824	48"	24"	87"	Adder	593.1	\$3,869.54		
	drawers: (4) 4 1/2" - 28 compartments and (3) 6" - 24 compartments								
	BHD2S-3624	36"	24"	99"	Starter	628.5	\$3,775.39		
	BHD2A-3624	36"	24"	99"	Adder	612.1	\$3,716.63		
	drawers: (4) 4 1/2" - 20 compartments and (5) 6" - 16 compartments								
	BHD2S-4824	48"	24"	99"	Starter	775.3	\$5,015.30		
	BHD2A-4824	48"	24"	99"	Adder	758.9	\$4,956.49		
	drawers: (4) 4 1/2" - 28 compartments and (5) 6" - 24 compartments								

RIVET-SPAN® Automotive Accessories

Catalog No.	Description	Size	Wt.	List Price
14150-001	Divider Arm	24"	1.4	\$30.95
10118-000	Loop Divider Arm	26" x 15"	3	\$118.45
10119-000-000	J Hook Rail (galvanized) (20 J Hooks included)	96"	3	\$246.95
10141-000-000	Heavy-Duty J Hooks w/washer	6-3/4"h x 2-1/4"w	0.3	\$9.12
10178-000-000	Plastic Label Holder	4'	0.3	\$4.26
10178-001-000	Plastic Label Holder	8'	0.5	\$8.42
10460-000-000	Magnetic Label Holder (dark brown)	4'	0.8	\$14.09
10127-000-000	Acrylic Divder Rod (clear)	3/16" x 6' 72"	.2	\$4.27
10128-000-000	Pegboard Decking (natural)	48" x 24" x 1/4"	9	\$26.67
10128-001-000	Pegboard Decking (natural)	48" x 36" x 1/4"	14	\$43.81
10129-000-000	Cardboard Sleeves (8 openings 5-1/2" x 24") (white exterior, natural interior)	48" x 48" x 24"	8.9	\$132.00

Note:

Rivet-Span automotive pre-configured units with (-) are basic units and do not include any specialty components other than divider arms, loop divider bars, wall ties or back spacer ties. Models with (+) are complete units and include all necessary wood decking/pegboard, cardboard sleeves, acrylic rods, J rails and hooks, or magnetic label holders.

Rivet-Span automotive pre-configured units' double rivet beams are Double Rivet Angle Beams except on Tire Racks which have Tire Beams in the left to right positions.

Support Ties not included in any pre-configured Rivet-Span automotive units. Refer to Beam Capacity Chart to access your application

Rivet-Span horizontal molding units' acrylic divider rods must be field cut to length.

All units shipped K.D.

Transmission Tear-Down Bench



Catalog No.	Unit Width	Unit Depth	Unit Height	Description	Wt.	List Price
11106-000	48"	28"	Adjustable	Fluid Containment Workbench Painted Top	96.9	\$1,197.41
11106-001	48"	28"	Adjustable	Fluid Containment Stainless Steel Top	91.9	\$1,489.97
11107-000				Replacement Fluid Drip Pan	1.0	\$39.92

Wall Mounted Cabinet



Catalog No.	Unit Width	Unit Depth	Unit Height	Description	Wt.	List Price
11114-000	36"	12"	27"	Wall Mounted Cabinet	80	\$837.04
11125-000	36"	12"	6"	Angled Top Kit	10	\$168.95

Taper Leg Enclosed Bench



(Shown with optional 6" high welded caster base (shown below) and stainless steel top (on page 48))

Catalog No.	Unit Width	Unit Depth	Unit Height	Wt.	List Price
WTL200	48"	28"	28"	251.7	\$1,958.00
WTL200SS	48"	28"	28"	251.7	\$2,402.40
WTL202	60"	28"	28"	264.7	\$2,031.70
WTL202SS	60"	28"	28"	264.7	\$2,535.50
WTL204	72"	28"	28"	277.7	\$2,123.00
WTL204SS	72"	28"	28"	277.7	\$2,657.60
WTL300	48"	28"	34"	269.6	\$1,889.80
WTL300SS	48"	28"	34"	269.6	\$2,332.00
WTL302	60"	28"	34"	300.4	\$1,936.00
WTL302SS	60"	28"	34"	300.4	\$2,442.00
WTL304	72"	28"	34"	329.4	\$2,062.50
WTL304SS	72"	28"	34"	329.4	\$2,563.00
WTL350	48"	28"	34"	269.6	\$1,960.20
WTL350SS	48"	28"	34"	269.6	\$2,405.70
WTL352	60"	28"	34"	300.4	\$2,037.20
WTL352SS	60"	28"	34"	300.4	\$2,539.90
WTL354	72"	28"	34"	329.4	\$2,127.40
WTL354SS	72"	28"	34"	329.4	\$2,626.80
Caster Base (Welded)					
11147-000	For 48" wide Taper Leg Enclosed Bench			50.0	\$471.11
11147-001	For 60" wide Taper Leg Enclosed Bench			55.0	\$495.26
11147-002	For 72" wide Taper Leg Enclosed Bench			60.0	\$558.52

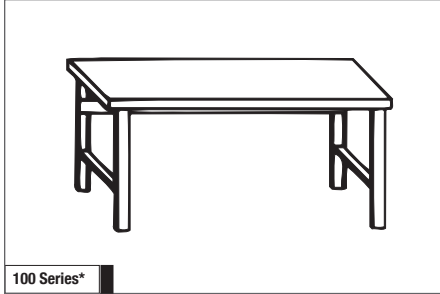

100 Series*

Catalog No.	Size	Wt.	List Price
WB100	48" x 28"	90.2	\$338.05
WB100SS	48" x 28"	90.2	\$708.16
WB101	48" x 34"	100.5	\$362.71
WB102	60" x 28"	103.2	\$375.56
WB102SS	60" x 28"	103.2	\$826.38
WB103	60" x 34"	115.6	\$398.64
WB104	72" x 28"	116.1	\$400.59
WB104SS	72" x 28"	116.1	\$885.35
WB105	72" x 34"	138.8	\$429.07

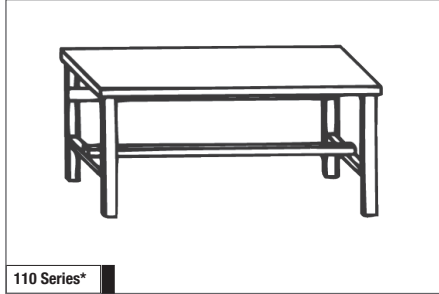

110 Series*

Catalog No.	Size	Wt.	List Price
WB110	48" x 28"	95.2	\$370.00
WB111	48" x 34"	105.5	\$394.70
WB112	60" x 28"	110.2	\$402.67
WB113	60" x 34"	122.6	\$434.91
WB114	72" x 28"	123.8	\$440.53
WB115	72" x 34"	138.5	\$469.02

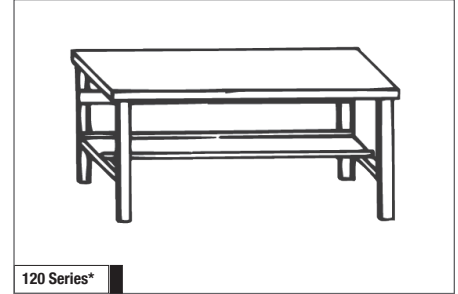

120 Series*

Catalog No.	Size	Wt.	List Price
WB120	48" x 28"	104.4	\$400.72
WB120SS	48" x 28"	104.4	\$834.14
WB121	48" x 34"	114.7	\$425.40
WB122	60" x 28"	121	\$432.50
WB122SS	60" x 28"	121	\$906.53
WB123	60" x 34"	133.4	\$464.78
WB124	72" x 28"	137.6	\$476.37
WB124SS	72" x 28"	137.6	\$881.36
WB125	72" x 34"	152.3	\$504.85

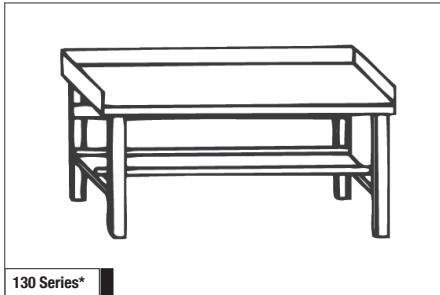

130 Series*

Catalog No.	Size	Wt.	List Price
WB130	48" x 28"	115.3	\$458.28
WB130SS	48" x 28"	115.3	\$903.14
WB131	48" x 34"	126.9	\$487.96
WB132	60" x 28"	133.1	\$490.09
WB132SS	60" x 28"	133.1	\$1,071.17
WB133	60" x 34"	146.7	\$527.36
WB134	72" x 28"	151	\$535.99
WB134SS	72" x 28"	151	\$1,147.52
WB135	72" x 34"	166.9	\$569.46

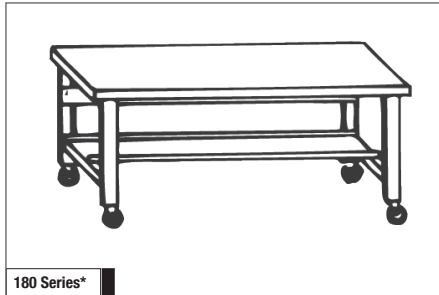

180 Series*

Catalog No.	Size	Wt.	List Price
WB180	48" x 28"	109.9	\$529.97
WB181	48" x 34"	120.2	\$554.63
WB182	60" x 28"	126.5	\$561.75
WB183	60" x 34"	138.9	\$594.07
WB184	72" x 28"	143.1	\$583.70
WB185	72" x 34"	157.8	\$634.07

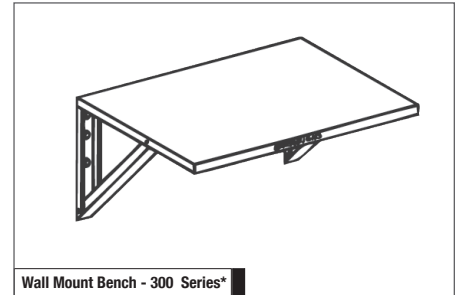

Wall Mount Bench - 300 Series*

Catalog No.	Size	Wt.	List Price
WMB300	48" x 28"	88.2	\$324.09
WMB300SS	48" x 28"	88.2	\$610.51
WMB302	60" x 28"	100.2	\$352.40
WMB302SS	60" x 28"	100.2	\$728.77
WMB304	72" x 28"	112.1	\$386.63
WMB304SS	72" x 28"	112.1	\$784.62
WMB305	72" x 34"	126.8	\$415.04

*Height is adjustable from 27-1/2" to 36" on 1" centers.

SS= Stainless Steel Top

All units shipped K.D.

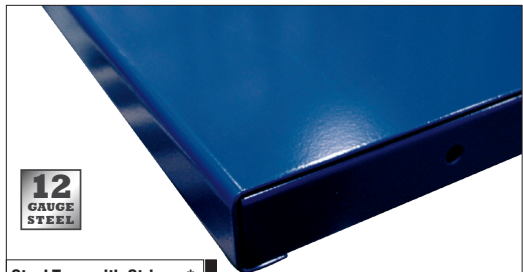

Steel Tops with Stringer*

Catalog No.	Size	Wt. Each	Qty. Per Pack	List Price
14881-S00	48" x 28" x 1-3/4"	61	1	\$219.81
14881-S01	48" x 34" x 1-3/4"	71.3	1	\$244.45
14881-S02	60" x 28" x 1-3/4"	74	1	\$266.67
14881-S03	60" x 34" x 1-3/4"	86.4	1	\$292.59
14881-S04	72" x 28" x 1-3/4"	86.9	1	\$275.56
14881-S05	72" x 34" x 1-3/4"	101.6	1	\$296.30



Solid Wood Tops

Catalog No.	Size	Wt. Each	Qty. Per Pack	List Price
00428-061	48" x 28" x 1-3/4"	64	1	\$561.97
00434-061	48" x 34" x 1-3/4"	78	1	\$642.84
00528-061	60" x 28" x 1-3/4"	80	1	\$660.51
00534-061	60" x 34" x 1-3/4"	98	1	\$757.28
00628-061	72" x 28" x 1-3/4"	97	1	\$743.18
00634-061	72" x 34" x 1-3/4"	117	1	\$857.69

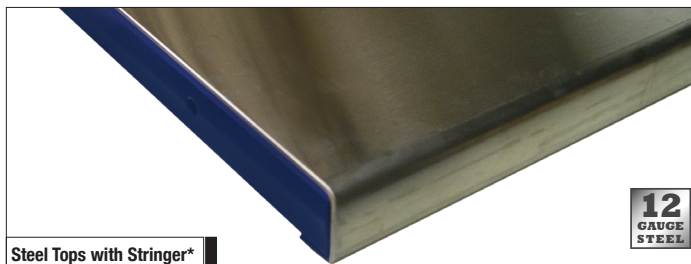

Steel Tops with Stringer*

Catalog No.	Size	Wt. Each	List Price
14820-S03-___*	SS Bench Top/Stringer 48" x 28"	61	\$564.96
14856-S02-___*	SS Bench Top/Stringer 60" x 28"	74	\$659.70
14857-S02-___*	SS Bench Top/Stringer 72" x 28"	86	\$710.56
14818-003-000	SS Back Guard Assembly 48"	5.1	\$63.66
14818-004-000	SS Back Guard Assembly 60"	6.3	\$102.62
14818-005-000	SS Back Guard Assembly 72"	7.6	\$104.15
14822-003-000	SS End Guard Assembly 28"	5.8	\$75.29

***NOTE:**
 To order any standard Borroughs open leg workbench with a stainless steel top, use the catalog numbers at left, adding a color suffix. Color must be specified since the stringer is included in the top kit. To calculate the unit price, deduct the price of the original painted steel top and add the price of the stainless steel top.



Catalog No.	Size	Wt. Each	Qty. Per Pack	List Price
Work Bench Leg Fits all bench tops listed on previous page				
•14828-000	27-1/2" to 36"h; 28" and 34"d	14.6	2	\$59.15

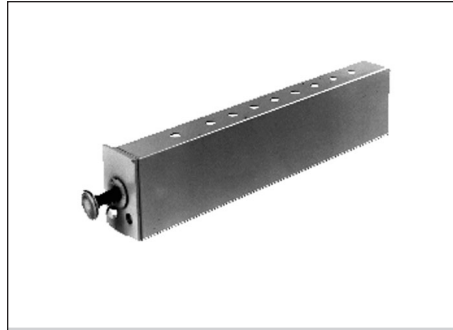

Catalog No.	Size	Wt. Each	Qty. Per Pack	List Price
Leveling Screw				
14825-000	-	0.7	price per pair	\$16.74
Replacement Adjustable Foot				
14809-000	-	1.28	1	\$34.96

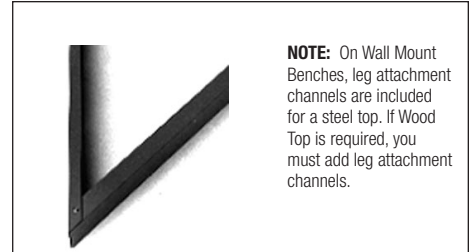

NOTE: On Wall Mount Benches, leg attachment channels are included for a steel top. If Wood Top is required, you must add leg attachment channels.

Catalog No.	Size	Wt. Each	Qty. Per Pack	List Price
Wall Mount Leg Price per pair				
11000-000	28" and 34"d	31	2	\$104.27
Leg Attachment Channels				
14813-000	28"	4.26	-	\$27.07
14813-001	34"	5.06	-	\$30.25

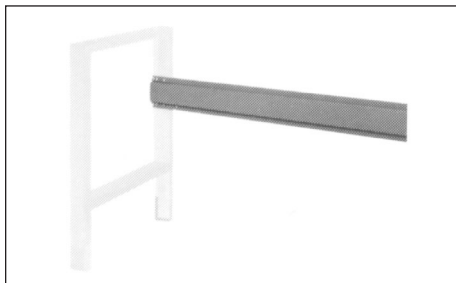

Catalog No.	Size	Wt. Each	Qty. Per Pack	List Price
Stringer				
14827-000	48"	3.8	6	\$24.32
14827-001	60"	4.8	6	\$28.01
14827-002	72"	5.8	6	\$31.87



Catalog No.	Size	Wt. Each	Qty. Per Pack	List Price
Bottom Shelf				
14826-000	48" x 15"	14.2	2	\$62.69
14826-001	60" x 15"	17.3	2	\$66.17
14826-002	72" x 15"	21.5	2	\$75.80

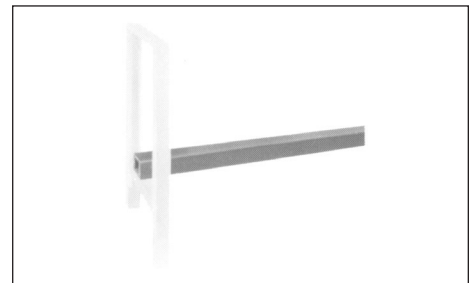

Catalog No.	Size	Wt. Each	Qty. Per Pack	List Price
Foot Rest				
14879-000	48"	5	4	\$32.01
14879-001	60"	7	4	\$36.29
14879-002	72"	7.7	4	\$39.97

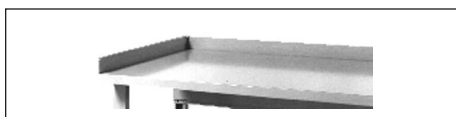

Catalog No.	Size	Wt. Each	Qty. Per Pack	List Price
Back Guard				
14824-000	48"	5.1	6	\$32.90
14824-001	60"	6.3	6	\$33.94
14824-002	72"	7.6	6	\$34.98
End Guard (price per pair)				
14822-000	28"	5.8	6	\$26.46
14822-001	34"	7	6	\$32.21

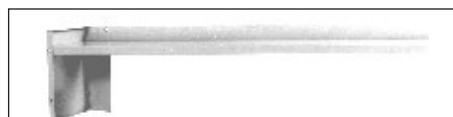

Catalog No.	Size	Wt. Each	Qty. Per Pack	List Price
Ledge or Top Shelf				
14851-000	48" x 10"	21.5	1	\$149.00
14851-001	60" x 10"	25	1	\$150.10
14851-002	72" x 10"	28.5	1	\$155.95



Catalog No.	Size	Wt. Each	Qty. Per Pack	List Price
Portable Kit				
14845-000	4" diameter	5.5	1	\$129.25

BOX EDGE
PLUS®

HD DRAWERS
IN SHELVING

RIVET-SPAN®
SHELVING

RECORD HOLDERS
& STORAGE

SLOTTED
ANGLE

AUTOMOTIVE
& SHOP STORAGE



Borroughs Corporation

3002 N. Burdick Street, Kalamazoo, MI 49004

t: 800-748-0227 | f: 269-342-4161 | www.borroughs.com

ISO 14001:2004 Registered

Printed in the USA | ©2018 Borroughs Corporation | Form # SSPL-10.1.2018-DIG